

# Emergency Preparedness Guide

For  
Disasters

**Information and easy-to-do preparedness activities to help you plan and prepare**



**ONE HOUR**  
Of disaster preparedness activity  
**EACH MONTH**  
Helps you be ready for disasters -  
whenever they occur.



~Compelling Photos~  
~Illustrated step-by-step Instruction~  
~Streaming Videos~



**For additional disaster preparedness information:  
[www.emd.wa.gov/preparedness](http://www.emd.wa.gov/preparedness)**



# IMPORTANT NUMBERS

County/City Emergency Management Offices  
[www.emd.wa.gov/myn/myn\\_contact\\_info.shtml](http://www.emd.wa.gov/myn/myn_contact_info.shtml)  
1.800.562.6108

**9-1-1** Call 9-1-1 only to report a life-threatening situation requiring police, medical or fire emergency assistance. Do not call 9-1-1 unnecessarily; lines must be kept open for people with true emergencies.  
**Information you will need to know:**  
*Location, Phone Number, Type of emergency, and name of those involved.*

**8-1-1** **Call Before You Dig: It's the Law!** Call 8-1-1 before beginning any excavation to ensure that any publicly owned underground facilities will be marked according to the APWA color code so that you can dig safely. Knowing these locations will help prevent damage to underground facilities, service interruptions, and bodily injury. The Utility Notification Center is open 24 hours every day, and accepts calls from contractors, homeowners, or anyone planning to dig.

**5-1-1** **Travel / Road Information:** State highway traffic and weather information is available by dialing 5-1-1 from most phones. **Receive:** \*Statewide traffic and road incidents, including construction and maintenance activities \*1-90 and I-5 express lane status \*Mountain pass weather, road conditions and restrictions \*Washington State Ferry information, including schedules, fares, wait times and *Wave to Go* fare pass information \*Statewide emergency messages and alerts including AMBER Alerts.

**4-1-1** **Telephone Directory Assistance:** Most phone companies allow you to access directory assistance service by dialing "4-1-1". Charges may vary depending on your service provider. Information you will need: city, state, street address, name and/or spelling of person or business.

**2-1-1** **Human Services:** Operators will provide you telephone numbers/contact information for:  
\*Basic Human Needs, \*Physical and Mental Health Resources \*Employment Supports \*Support for Elder Americans and Persons with Disabilities \*Support for Children, Youth and Families \*Volunteer Opportunities and Donations.

## Poison Control: 1-800-222-1222

### Business Numbers:

Power: \_\_\_\_\_ Police: \_\_\_\_\_ Fire: \_\_\_\_\_

### Family Numbers:

Name: \_\_\_\_\_ Number: \_\_\_\_\_

Name: \_\_\_\_\_ Number: \_\_\_\_\_

Name: \_\_\_\_\_ Number: \_\_\_\_\_

Name: \_\_\_\_\_ Number: \_\_\_\_\_

### Out-of-Area Contact Number:

Name: \_\_\_\_\_ Number: \_\_\_\_\_

# Table of Contents

## Prepare in a Year

Disaster Planning Basics .....	1
Out-of-Area Contacts.....	2
Storing Water.....	3
72-Hour Comfort Kits.....	5
Important Documents.....	7
Extended Events	
• Supplies .....	8
• Food.....	9
• Pets.....	10
• Sanitation.....	11
Under the Bed Items.....	12
Utility Safety.....	13
Drop, Cover & Hold On.....	14
Fire Safety.....	15
Shelter-In-Place.....	17
Home Hazard Hunt.....	19

## Getting Ready – Home

Secure Wall Hangings.....	21
Secure Tall Furniture & Objects.....	22
Kitchen & Cabinet Safety.....	23
Securing the Water Heater.....	24
Garage & Storage Safety.....	25
Structural Mitigation.....	26

## Map Your Neighborhood.....

27

## Hazards

Earthquakes.....	28
Floods.....	29
Landslides and Mud Flows.....	30
Tsunami.....	31
Volcanoes.....	32
Hot Weather.....	33
Wildfires.....	34
Windstorms.....	35
Winter Storms.....	36
Power Outages & Generators.....	37
Carbon Monoxide Safety.....	38
Vehicle Safety & Preparedness.....	39

## Specific Needs

Take Care of Your Psychological and Emotional Needs.....	40
Helping Children After a Disaster.....	41
Disaster Tips for People with Special Medical Needs.....	42
Disaster Tips for People with Mobility Disabilities.....	43
Preparedness Tips for the Deaf & Hard of Hearing.....	44
Disaster Tips for People with Visual Disabilities.....	45



# Disaster Planning - Basics

Communities throughout the Pacific Northwest are subject to many types of disasters. While we hope that such occurrences never happen it has been shown time and time again that being prepared for disasters is prudent.

Experts tell us to plan to be on our own for a minimum of 3 days.

## What Disasters can affect you?

- Ask what types of disaster are most likely to happen in your area.
- Learn about your community's warning signals: what they sound like and what you should do when you hear them. Also, learn which radio stations will provide emergency information for your area.
- Ask about animal care.
- Find out how to help the elderly or disabled persons in your neighborhood.
- Find out about the disaster plans at your workplace, your children's school or childcare center and other places your family frequently visits.

## Create a Disaster Plan:

- Meet with your family and discuss why you need to be prepared for disasters. Plan to share the responsibilities and work together as a team.
- Discuss the types of disasters that are most likely to happen. Explain what to do in each case.
- Discuss what to do in an evacuation. Plan to take care of your pets.
- Ask an out-of-area friend or relative to be your "contact". It's often easier to call long distance following a disaster. (see page 2).
- Pick two places to meet:
  - Right outside your home in case of fire.
  - Outside your neighborhood in case you can't return home. Everyone must know the address and phone number.

\_\_\_\_\_

\_\_\_\_\_

Phone # \_\_\_\_\_

## Put your Plan into Action:

- Post emergency telephone numbers by phones.
- Teach children how and when to call 911 or your local emergency medical services number for emergency help. Show them how your cell phone works.
- Show each family member how and when to turn off the water, gas, and electricity at the main switches.
- Check for adequate insurance coverage.
- Install an ABC fire extinguisher in your home, teach each family member to use it, and where it is kept. (see pages 15-16)
- Install smoke and carbon monoxide detectors on each level of your home, in appropriate areas.
- Conduct a home hazard hunt. (see pages 19-20)
- Stock emergency supplies and assemble a disaster supplies kit. (see pages 5-6)
- Take a first aid and CPR class.
- Determine the best escape routes from your home. Find two ways out of each room.
- Find safe spot in your home for each type of disaster.

## Practice and Maintain Your Plan:

- Review your plans every six months so everyone remembers what to do.
- Conduct fire and emergency evacuations drills.
- Test and recharge your fire extinguishers according to manufacturer's instructions.
- Test your smoke and carbon monoxide detectors every month, replace batteries every six months.
- Replace stored water and food every six months.

*HINT: You change your clocks in the Spring & Fall. This is a great time to review your plans, practice your drills, change the batteries in your detectors, and replace food and water.*



WASHINGTON MILITARY DEPARTMENT  
Emergency Management Division  
Camp Murray, WA 98430-5122

Web site [www.emd.wa.gov](http://www.emd.wa.gov)  
253 512 000 (800) 562-6108

Prepare in a Year



# Out-Of-Area Contacts

## Preparing to be separated from loved ones:

If you are separated from your loved ones when disaster strikes, you immediately will wonder how and where they are. The stress of the event may make it difficult to remember even routine information, like phone numbers. We recommend that every household member have an out-of-area contact card in a wallet, purse, or backpack at all times.

## Contacting love ones after disasters:

- Ask an out-of-area friend to be your contact person. This person should live at least 100 miles away from you. See the "Did You Know" to find out why you can make long distance but not local calls.
- After a disaster, all household members call this person to tell her or him how they are and to find out how other household members are.
- Make small cards with this person's name and phone number for all family members to carry in their wallets, purses, or backpacks.

## Did you know:

- Phone lines were "hardened" years ago to withstand nuclear attack and are quite resistant to damage. It's difficult to make local calls not because of damage, but because of the number of people trying to call at the same time. Typically, however, you can make long distance calls.
- One reason the local phone system shuts down during earthquakes is because handset gets knocked from their bases. Help restore local phone service by making sure all your phones are hung up.
- You should keep a phone that does not require electricity. Cordless phones use electricity - if power is out, they will not work.
- Pay phones are part of the emergency services network and are a priority to be restored to service. Locate one near your neighborhood, school, and workplace. Tape the coins needed to use a pay phone to your out-of-area contact card.

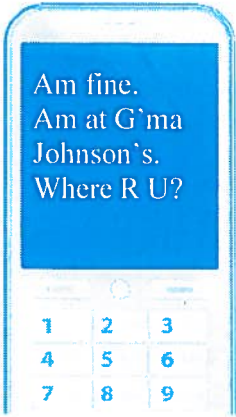

**OUT OF AREA CONTACT PERSON**

*WHY?* Local phone systems may be shut down in a disaster. However, you frequently can place a long-distance call.

Name (print): \_\_\_\_\_

Phone number (with area code): \_\_\_\_\_

Cell phone number (with area code): \_\_\_\_\_

*TIP:* You may be able to text message all your loved ones on your cell phone. Keep these messages short.

---

DISASTER meeting place (if you cannot return home):

EXACT LOCATION \_\_\_\_\_

HOUSE FIRE meeting place (near home, everyone is safely outside):

EXACT LOCATION \_\_\_\_\_

LOCAL emergency contact (if you are hurt):

PRINT NAME \_\_\_\_\_ PHONE \_\_\_\_\_

Front

Back



WASHINGTON MILITARY DEPARTMENT  
Emergency Management Division  
Camp Murray WA 98430 5122

Web site [www.emd.wa.gov](http://www.emd.wa.gov)  
253-512-000, (800) 562-6108

Prepare in a Year



# Storing Water

## Preventing thirst after a disaster:

Water is essential for survival. The ground trembling and shaking caused by earthquakes can crack or break the lines that bring fresh water to your house. You may have to rely for three days or more on the water you have stored.

## How much water should I store?

**Three (3) gallons for each person** in your household is the minimum amount required to take care of drinking, cooking, and hygiene needs for the first 72 hours of a disaster.

## Which containers are good?

Plastic containers with a screw-cap lid, such as two-liter soda pop bottles or food-grade plastic jugs, work great.

**If you use two-liter soda pop bottles, plan to store at least six (6) of these for each person in your household.**

Do not use glass bottles or old bleach bottles (or any container that has held a toxic substance). Glass breaks too easily. The plastic of old bleach bottles contains substances that, over time, get into the water and make it unfit for drinking.

Avoid the use of plastic milk jugs. They are difficult to seal tightly, and their plastic becomes very fragile and brittle over time.



## Can I improve the taste of stored water?

Stored water will taste better if you put oxygen back into it by pouring the water back and forth between two clean containers several times.

## Storing Water:

1. Choose containers that have a tight-fitting screw-cap lid. Two-liter pop bottles are a great choice.
2. Thoroughly rinse out the container and the lid with water, and fill it to the very top of the container.



For extra safety, thoroughly rinse the container with a weak solution of liquid chlorine bleach (8-10 drops in two cups water). Empty this solution out and fill the container right to the top with fresh water.

3. Seal the container tightly.
4. Label it "drinking water" and date it.
5. Store it in a cool, dark place. Examples:
  - under the bed
  - in the corner of closets
  - behind the sofa

*Hint: To make it easy to find many places to put your water, think about this activity as a priority rather than an inconvenience.*

## Is adding liquid bleach recommended?

In March, 1994 the Food and Drug Administration and the Environmental Protection Agency stated:

- Tap water does not need anything added to it before it is stored because it has already been chemically treated.
- Commercially purchased water does not need anything added to it. Keep it in its original, sealed container.



WASHINGTON MILITARY DEPARTMENT  
Emergency Management Division  
Camp Murray WA 98430-5122

Web site [www.emd.wa.gov](http://www.emd.wa.gov)  
253-512-7000 (800) 562-6100

Prepare in a Year



# Storing Water - cont.

## What about rotation?

It is recommended that water be rotated every six months.

## Treating water of questionable purity:

- Filter the water to remove as many solids as possible. Coffee filters, cheesecloth, or several layers of paper towels work well.
- Bring the water to a rolling boil for a full 10 minutes.
- Let it cool for at least 30 minutes. Water must be cool or the chlorine you add next will dissipate and be **rendered useless**.
- **Add 1/8 teaspoon of liquid chlorine bleach per gallon of cool water or 8 drops per two-liter bottle.** The only active ingredient in the bleach should be 6.00% sodium hypochlorite and there should be no added thickeners, soaps, or fragrances.
- Let it stand for 30 minutes.
- If it smells of chlorine, you can use it. If it does not smell of chlorine, add 16 more drops of chlorine bleach per gallon, let it stand for another 30 minutes, and smell it again. If it smells of chlorine, you can use it.

If it does not smell of chlorine, discard it and find another source of water.

## Distillation - A second method of purification:

1. Fill a pot halfway with water.
2. Tie a cup to the handle on the pot's lid so that the cup will hang right side up when the lid is placed upside down on the pot (make sure the cup is not dangling in the water).
3. Boil the water for 20 minutes. The water that drips from the lid into the cup is distilled.

This method allows the vapor resulting from boiling water to collect in the cup. This condensed vapor will not include salts or other impurities.

## Additional information:

- The only thing that should be used to purify water is liquid household bleach containing 6.00% sodium hypochlorite and no thickeners, soaps, or fragrances.
- Other chemicals, such as iodine or products sold in camping or surplus stores have a short shelf life and are not recommended and should not be used.
- Boiling water kills bacteria, viruses, and parasites that can cause illness. Treating water with chlorine bleach kills most viruses, but will probably not kill bacteria. Therefore, boiling and then adding chlorine bleach is an effective water purification method.
- The only accepted measurement of chlorine is the drop. A drop is specifically measurable. Other measures, such as "capful" or "scant teaspoon" are not uniformly measurable, and should not be used.
- There is no difference in the treatment of potentially contaminated water that is cloudy or that which is clear.

SOURCE: FDA and EPA Report, 1994



distillation is an effective method of water purification



WASHINGTON MILITARY DEPARTMENT  
Emergency Management Division  
Camp Murray, WA 98430-5122

Web site [www.emd.wa.gov](http://www.emd.wa.gov)  
253-512-7000 (800) 562-6108

## Watch these videos:

- Turning Off Water
- Extra Water Source

[www.emd.wa.gov/preparedness/prep\\_personal\\_prep\\_video\\_index.shtml](http://www.emd.wa.gov/preparedness/prep_personal_prep_video_index.shtml)

# 72-hour Comfort Kits

## Storing Emergency Supplies:

Chances are you will have to rely upon supplies you have available in your home for at least the first three days following any major disaster.

Store these items in something that is portable and easily carried, like a plastic tub with a tight-fitting lid. In the event of fire or rapid evacuation, you'll appreciate having more than just the clothes on your back.

The container should be able to withstand moisture, insects, and some abuse when the quake happens. If you have a large family, several smaller tubs may be easier to carry than one large container.

Place items in plastic bags to protect against condensation, which causes mildew and rust. The bags newspapers come in are a good choice - these can later be used for disposing of waste.

Locate these supplies as close to your primary house exit as possible. You may have to find it in the dark or after the upheaval of an earthquake.

## Water:

Keep at least a three-day supply of water for each person in your household. Two-liter soda pop bottles work great. That means six two-liter bottles per person. (see pages 3-4 for more information on storing an emergency supply of water.)

## Food:

Store at least a three-day supply of non-perishable food. Select foods that require no refrigeration or cooking, and little or no water, such as:

- canned meats, fruits, and vegetables
- canned juices and soups
- high energy foods – peanut butter, granola bars, trail mix, beef jerky
- “comfort” foods – cookies, hard candy

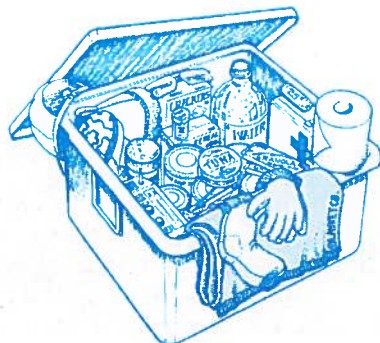

## First Aid Supplies:

- sterile 4" adhesive bandages
- sterile 4" x 4" gauze pads
- 4" rolled gauze bandages
- large triangular bandages
- butterfly bandages
- adhesive tape
- scissors and tweezers
- moistened towelettes
- bar soap
- latex gloves
- aspirin
- non-aspirin pain reliever
- antacid
- anti-diarrhea medication
- insect repellent
- hydrogen peroxide to disinfect wounds
- antibiotic ointment to dress wounds
- sunscreen
- safety pins
- needle & thread
- plastic bags
- sanitary pads
- instant cold packs
- pocket knife
- splinting materials

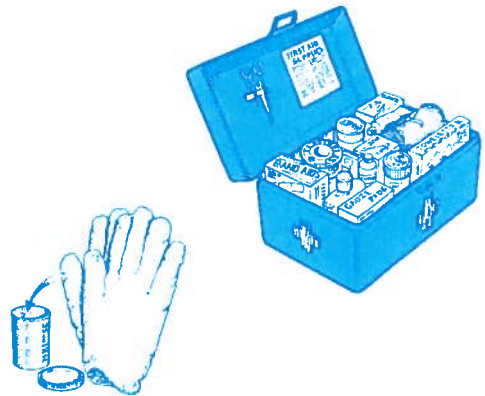

*use a prescription bottle or film canister to store an extra pair of latex gloves in the car glove compartment*



WASHINGTON MILITARY DEPARTMENT  
Emergency Management Division  
Camp Murray WA 98430-5122

Web site [www.emd.wa.gov](http://www.emd.wa.gov)  
253 512-7000 (800) 562-6108





# 72-hour Comfort Kits – cont.

## Tools & Supplies:

- paper cups, plates, and plastic utensils
- battery-operated AM radio
- extra batteries
- flashlight
- non-electric can opener
- ABC fire extinguisher
- whistle
- toilet paper and towelettes
- liquid soap
- feminine supplies
- roll of plastic
- duct tape to seal broken windows

## Special Items:

- extra eye glasses
- prescription drugs and medications
- baby formula, food, and diapers
- a family picture
- games and books
- copies of insurance policies
- bank account numbers
- inventory of valuables
- family records
- contact lens solution
- denture adhesive

## Clothing & Bedding

- one complete change of clothes
- blankets or sleeping bags
- mylar blankets
- sturdy shoes
- warm socks
- hat and gloves



*Plan to rotate the items in your kit annually.  
This includes making sure the clothes you have packed still fit!*

*Preparing for disasters is a long-term goal. To make this task manageable, choose just two or three items that you will purchase each month.*

### Month #1

Item #1 \_\_\_\_\_

Item #2 \_\_\_\_\_

### Month #2

Item #1 \_\_\_\_\_

Item #2 \_\_\_\_\_

### Month #3

Item #1 \_\_\_\_\_

Item #2 \_\_\_\_\_

### Month #4

Item #1 \_\_\_\_\_

Item #2 \_\_\_\_\_

### Month #5

Item #1 \_\_\_\_\_

Item #2 \_\_\_\_\_

### Month #6

Item #1 \_\_\_\_\_

Item #2 \_\_\_\_\_



WASHINGTON MILITARY DEPARTMENT  
Emergency Management Division  
Camp Murray WA 98430-5122

Web site [www.emd.wa.gov](http://www.emd.wa.gov)  
253-512-7000 (800) 562-6108

Prepare in a Year



# Important Documents

## Preparing to Recover:

After a major disaster, you may need financial assistance and will want to document any property loss for insurance and income tax purposes. Have ready access to the documents necessary for completing application forms, as well as those which could be difficult to replace. This will help reduce delay and frustration.

## At a Minimum:

1. Gather property insurance papers (home, auto, boat, etc.) and make copies.
2. Gather health insurance papers (medical provider, dental provider, life - do not resuscitate, extended disability, etc.) and make copies.
3. Gather financial papers (bank, investment, retirement, etc.) and make copies.
4. Gather wills, powers of attorney, and estate papers and make copies.
5. Take photos or video of all valuable as documentation for insurance claims.

*Store these copies and photos in a safe deposit box or in a zip lock bag in your freezer (you may want to disguise these documents by putting them in a clean box like a frozen pizza box).*

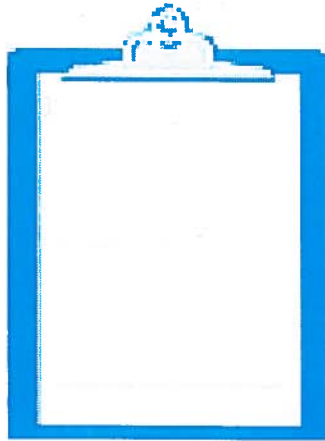

*Suggestion: Copy all your important documents on to a USB drive. Make one for yourself and send one to your out-of-area contact.*

## Important Contact Information:

Because it may be difficult to think during the stress of a disaster and because normal routines have been disrupted, take a few moments and create a written record of these important phone numbers.

### Work

Adult Name: \_\_\_\_\_

Place of Work: \_\_\_\_\_

Work Phone: \_\_\_\_\_

Cell Phone: \_\_\_\_\_

Email Address: \_\_\_\_\_

Adult Name: \_\_\_\_\_

Place of Work: \_\_\_\_\_

Work Phone: \_\_\_\_\_

Cell Phone: \_\_\_\_\_

Email Address: \_\_\_\_\_

### School / Daycare

Child Name: \_\_\_\_\_

School Name: \_\_\_\_\_

School Phone: \_\_\_\_\_

Child Name: \_\_\_\_\_

School Name: \_\_\_\_\_

School Phone: \_\_\_\_\_



WASHINGTON MILITARY DEPARTMENT  
Emergency Management Division  
Camp Murray WA 98430-5122

Web site [www.emd.wa.gov](http://www.emd.wa.gov)  
253-512-7000 (800) 562-6108

Prepare in a Year



# Extended Events - Supplies

## Choosing comfort over inconvenience:

Coping with the impact of a disaster is never fun. However, much of the inconvenience and discomfort can be reduced by planning alternative ways to take care of your needs.

## Acquiring emergency supplies:

At first glance, the list below may seem totally over-whelming. At second glance, you'll find that you probably already have many of these items.

- Check those items you already have.
- Circle those you don't have, but are important to the comfort of you and your loved ones.
- Choose two of these circled items and add them to your weekly shopping list.

## Lighting:

*Caution: The use of candles is no longer recommended as a source of emergency light. Experience shows they are responsible for too many secondary fires following the disaster. Additionally, they are very dangerous in the presence of leaking natural gas.*

- Flashlight and extra batteries.
- Camping lanterns - store extra fuel, wicks, mantles, and matches.
- Light sticks - these can provide light for 1 to 12 hours and can be purchased at many camping supply stores.

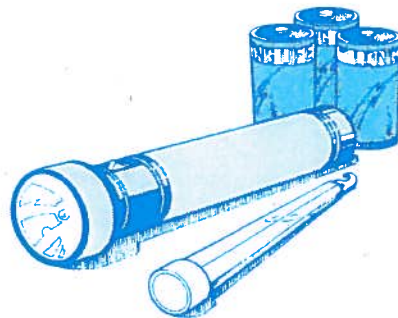

## Cooking:

*Caution: Never burn charcoal indoors. This could cause carbon monoxide poisoning.*

- Camp stoves, sterno stove, or barbecues - store extra propane, charcoal or sterno, lighter fluid, and matches.
- Fireplaces - do not use until the chimney and flue have been inspected for cracks. Sparks may escape in to your attic through an undetected crack and start a fire.
- Paper plate and cups.
- Plastic utensils.

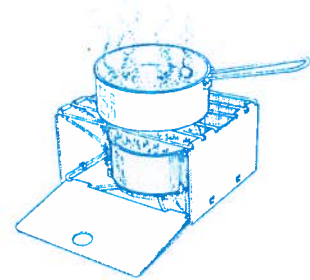

## Shelter:

It is common for people to not want to sleep in their homes for the few days following a major earthquake. Having an alternate means of shelter will help you and your family be as comfortable as possible.

- Tent or waterproof tarp.
- Sleeping bags or blankets and pillows.
- Rain gear.
- Mylar blankets are compact and easy to store.
- Newspapers provide insulation from the cold or heat.



WASHINGTON MILITARY DEPARTMENT  
Emergency Management Division  
Camp Murray WA 98430-5122

Web site [www.emd.wa.gov](http://www.emd.wa.gov)  
253-512-7000 (800) 562-6108



# Extended Events - Food

## Protecting stored foods when the power goes out:

- Keep refrigerator and freezer doors closed as much as possible.

A full refrigerator will maintain safe temperatures for up to six hours.

A full freezer will maintain safe temperatures for one or two days; a half-full freezer one day.

Discard at-risk refrigerated foods that are warmer than 40° Fahrenheit. If in doubt, throw it out.

- If you think the power will be out for several days, try to find some ice to pack inside the refrigerator and freezer.

Remember to keep your raw foods separate from your ready-to-eat foods.

## Foods to be concerned about:

Foods are categorized into groups:

- Potentially hazardous foods** are the most important. These include meats, fish, poultry, dairy products, eggs and egg products, soft cheeses, cooked beans, cooked potatoes, cooked pasta, custards, puddings, etc.
- Some food **may not be hazardous** but the quality may be affected. These foods include salad dressings, mayonnaise, butter, margarine, produce, hard cheeses, etc.
- Some food are **safe**. These are carbonated beverages, unopened bottled juices, ketchup, mustard, relishes, jams, peanut butter, barbecue sauces, etc.

## When do I save and when do I throw out food?

- Refrigerated foods should be safe as long as the power is out no more than a few hours and the doors have been kept closed. **Potentially hazardous foods** should be discarded if they warm up to above 40°F.
- Frozen foods which are still frozen are not a problem.
- If **potentially hazardous foods** are thawed but still have ice crystals you should use them as soon as possible.
- If **potentially hazardous foods** are thawed and warmer than 40°F you should discard them.

## How do I know if the food is unsafe to eat?

- You cannot rely upon appearance or odor. Never taste food to determine its safety.
- Some foods may look and smell fine, but if they've been warm too long, food poisoning bacteria may have grown enough to make you sick.
- If possible, use a thermometer to check the temperature of foods. If potentially hazardous foods are cooler than 40°F they are safe.

## What happens when the power goes back on?

- Allow time for refrigerators to reach the proper temperature of lower than 40°F before restocking. Start with all fresh foods.

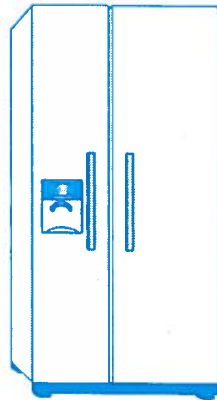

## REMEMBER!

*When in doubt,  
throw it out.*



WASHINGTON MILITARY DEPARTMENT  
Emergency Management Division  
Camp Murray WA 98430-5122

Web site: [www.emd.wa.gov](http://www.emd.wa.gov)  
253-512-7000 (800) 562-6108

# Extended Events - Pets

## Before a disaster:

- Decide on safe locations in your house where you could leave your pet in an emergency. Consider easy to clean areas such as utility rooms or bathrooms. Avoid rooms with hazards such as windows, hanging plants, and pictures.
- Plan to set up a separate location for each animal. Disasters stress animals and even a gentle pet can exhibit distressed behaviors.
- If your pet is on medication or a special diet, find out from your vet what you should do in case you have to leave it alone for several days. Try to get an extra supply of medications.
- Make sure your pet has a properly fitted collar that includes the current license and rabies tags and your name, address, and phone numbers.

## Emergency supplies for pets:

- Fiberglass carrier for each pet with an envelope taped to the top of the carrier containing: a photo with your pet's name on it, vaccination records, information about prescription medications, and your vet's name and phone numbers.
- Train your pet to become comfortable being in the carrier.
- Food should be dry and relatively unappealing to prevent overeating.
- Towels or blankets for warmth.
- Water sufficient for three days.
- Ziploc baggies for cleanup.
- Spray disinfectant and latex gloves.

## In addition, cats need:

- Plastic litter box.
- Jug of clumping kitty litter and a scoop.



## During a disaster:

- Bring your pets inside immediately. Animals have instincts about severe weather changes and will often isolate themselves if they are afraid. Bringing them inside early can stop them from running away. Never leave a pet outside or tied up during a storm.
- If you evacuate and have to leave your pet at home, prepare a safe location for it.
  - Leave a three day supply of dry food, even if it is not the pet's usual food. Moistened food can turn rancid or sour. Put the food in a sturdy container the pet cannot overturn.
  - Leave water in a sturdy, no-spill container. If possible open a faucet slightly and let the water drip into a big container.
  - Replace a chain "choke" collar with a leather or nylon collar. Make sure the collar has tags and identification.
- Separate dogs and cats. Even if they normally get along, the anxiety of a disaster situation can cause pets to act unpredictably.
- If you evacuate and plan to take your pets, remember to bring your pets' medical records and medicines.

*For health and safety reasons, pets will not be allowed in most public emergency shelters.*

## After a disaster:

- In the first few days after the disaster, leash your pets when they go outside. Maintain close contact since familiar scents and landmarks may be altered and your pet may become confused and lost.
- The behavior of your pets may have changes. Normally quiet and friendly pets may become aggressive and defensive. Leash dogs and place them in a fenced yard with access to shelter and water.



WASHINGTON MILITARY DEPARTMENT  
Emergency Management Division  
Camp Murray, WA 98430-5122

Web site [www.emd.wa.gov](http://www.emd.wa.gov)  
253-512-7000, (800) 562-6108

# Extended Events - Sanitation

## Sanitation:

- The lack of sanitation facilities following major disasters can quickly create secondary problems unless basic guidelines are followed. If the water lines are damaged or if damage is suspected do not flush the toilet.
- Avoid digging holes in the ground and using these. Untreated raw sewage can pollute fresh ground water supplies. It also attracts flies and promotes the spread of diseases.
- Store a large supply of heavy-duty plastic bags, twist ties, disinfectant, and toilet paper.
- A good disinfectant that is easy to use is a solution of one-part liquid bleach to ten-parts water.
- Portable camp toilets, small trash cans, or sturdy buckets lined with heavy-duty plastic bags can be used. Those with tight fitting lids are best.



*Note: Dry bleach is caustic and not safe for this type of use.*

- Large zip lock plastic bags and toilet paper should be kept at work and in the car for use if you are away from home. These can be wrapped in newspaper in preparation for future disposal.



- If the toilet is not able to be flushed, it can still be used. This is less stressful for most people than using some other container. Remove all the bowl water. Line bowl with a heavy-duty plastic bag. When finished, add a small amount of deodorant or disinfectant, securely tie the bag, and dispose of it in a large trash can with a tight fitting lid. This large trash can should also be lined with a sturdy trash bag.



WASHINGTON MILITARY DEPARTMENT  
Emergency Management Division  
Camp Murray, WA 98430-5122

Web site [www.emd.wa.gov](http://www.emd.wa.gov)  
253-512-7000 (800) 562-6108



# Under-the-Bed Items

## Ready to respond - day or night:

When disaster strikes, it may be difficult to think as rationally and as quickly as you would like. The more procedures you have in place, and the easier they are to remember and implement, the more effective and efficient will be your response.

## At a minimum:

Keep a pair of sturdy shoes to protect your feet by each loved one's bed at all times.

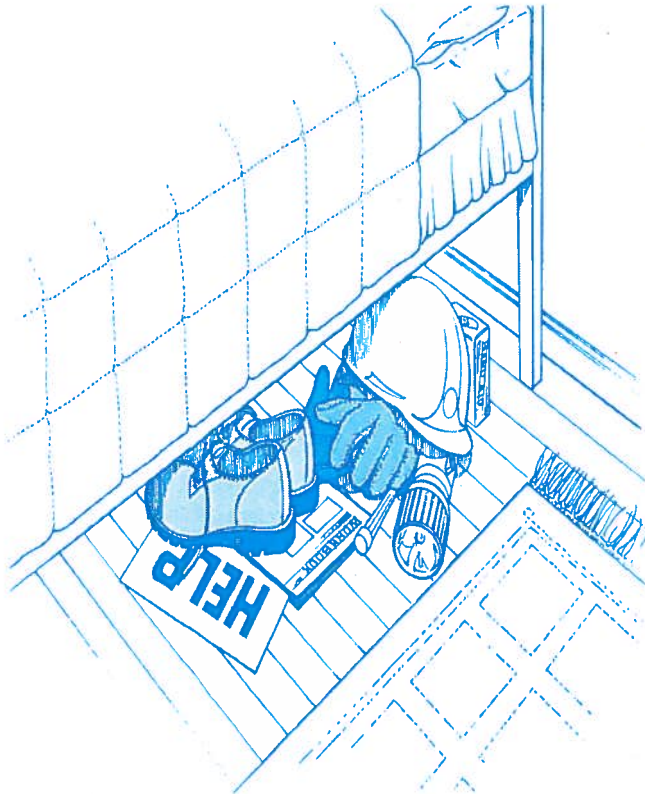

## Critical under-the-bed items:

- Sturdy shoes - to protect your feet from broken glass. Injuries to feet are the number one injury after an earthquake. Windows, picture frames, lamps, and clocks can all produce glass shards that could cause injury.
- Work gloves, preferably leather - to protect your hands from broken glass.
- Hardhat - to protect you from falling objects like chimney bricks and downed trees and branches.
- Flashlight & light sticks - essential for a nighttime response.
- An OK/HELP card, found either in your MYN (Map Your Neighborhood) handout which is available from your local office of emergency management or one that you prepare yourself.
- A few bandaids - to hang the OK/HELP card in the window or front door.



WASHINGTON MILITARY DEPARTMENT  
Emergency Management Division  
Camp Murray WA 98430-5122

Web site [www.emd.wa.gov](http://www.emd.wa.gov)  
253 512-7000 (800) 562-6108

Prepare in a Year

# Utility Safety

Watch the videos:  
[www.emd.wa.gov/preparedness/prep\\_personal\\_prep\\_video\\_index.shtml](http://www.emd.wa.gov/preparedness/prep_personal_prep_video_index.shtml)

## Natural Gas :

Natural gas leaks and explosions are responsible for a significant number of fires following any major earthquake. It is vital that all household members know how to shut off the natural gas.

### Preparing to shut off the natural gas:

- Locate the shut-off valve (see illustration). Make sure this valve will turn. To shut off the gas, turn the valve 90° or 1/4 turn, so that it crosses the pipe (see illustration).

If your valve is rusted open, do not put WD-40™ lubricant on it. It may corrode the O-rings that allow the valve to turn.

- Attach a wrench to the meter or to the wall directly behind the meter.



- choose a crescent wrench that is at least 12" long
- adjust it to fit your valve before hanging it behind the meter in case it rusts

### Shutting off the gas after an earthquake:

- Shut off the gas immediately only if you smell the characteristic odor of gas, you hear a hissing sound, and/or you notice the meter dials spinning more rapidly than normal.
- Do not use matches, lighters, open flame appliances, or operate any electrical switches until you are sure no gas leaks exist. Sparks from electrical switches could ignite the gas.
- If you smell natural gas, immediately get everyone out of and away from the house. Open the windows and doors to provide ventilation. Shut off the gas at the meter.

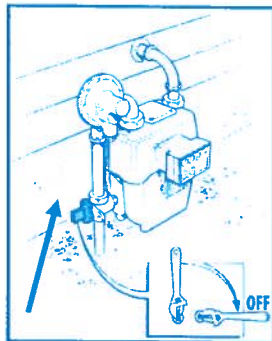

The shut-off valve is located on the pipe that comes out of the ground.

## Water:

Water quickly becomes a precious resource following many disasters. It is vital that all household members learn how to shut off the water at the main house valve.

- Cracked lines may pollute the water supply to your house. It is wise to shut off your water until you hear from the authorities that it is safe for drinking.
- The effects of gravity may drain the water in your hot water and toilet tanks unless you trap it in your house by shutting off the main house valve (not the street valve in the cement box at the curb – this valve is extremely difficult to turn and requires a special tool).

- Locate the shut-off valve for the water line that enters your house. It may look like this: →

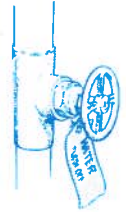

- Make sure this valve can be completely shut off. Your valve may be rusted open or it may only partially close. Replace it if necessary.
- Label this valve with a tag for easy identification, and make sure all household members know where it is located.

## Electricity:

Electrical sparks have the potential of igniting natural gas if it is leaking. It is wise to teach all responsible household members where and how to shut off the electricity.

### Preparing to shut off electricity:

- Locate your electricity circuit box.
- Teach all responsible household members how to shut off the electricity to the entire house.

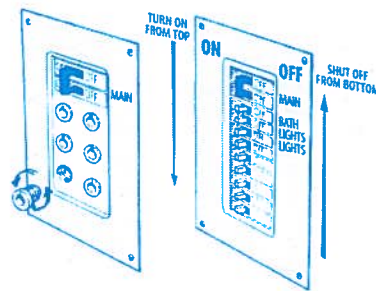

FOR YOUR SAFETY: Always shut off all the individual circuits before shutting off the main circuit breaker.



WASHINGTON MILITARY DEPARTMENT  
 Emergency Management Division  
 Camp Murray, WA 98430-5122

Web site [www.emd.wa.gov](http://www.emd.wa.gov)  
 253-512-7000 (800) 562-6108





# Drop•Cover•Hold On

## Conquering the instinct to run:

During earthquakes many people's fight/flight instinct urges them to *run!* - even when they *know* they should "drop, cover, hold on."

Why? Rational thought (in other words, the *knowing*) flees. We learn to counter this instinctual response to run by *practicing* doing the safe thing.

Studies show that people in our country tend to be hurt by falling objects, not collapsing structures. If you are on your feet trying to move, you are in danger from toppling bookcases, breaking windows, flying dishes, falling televisions, collapsing fireplaces, or shifting furniture. Safety comes from quickly getting to a place of safety.

## Practicing being safe:

1. **Choose** a safe place to go in each room:

- Bedrooms
- Bathroom
- Living Room
- Kitchen
- Play room
- Garage

2. **Practice** quickly moving to that safe place.

3. **Conduct *Earthquake Drills*** to practice taking cover in your safe places.

Regularly call out "earthquake!!" Allow everyone time to react. Then come together and discuss where each of you went and why it was or was not the safest place to go.

## Key to Success: Practice, Practice!

Practicing is what helps us ensure you will quickly move to your safe place instead of responding to the instinctive urge to run.

## Drop•Cover•Hold On: What Does it Mean?

- *Drop* - under something sturdy and taller than you are
- *Cover* - the back of your head and neck with one arm
- *Hold on* - in case the thing you're under moves

Close your eyes - you'll do better psychologically if you don't watch and you'll protect your eyes.

**"Drop•Cover•Hold On" is the national standard for earthquake safety in our country.** You may have read articles claiming the value of the "triangle of life." Many of the facts used to justify its merits are unproven and questionable.

Whenever the ground begins to shake, and wherever possible, quickly take cover under a sturdy desk or table.

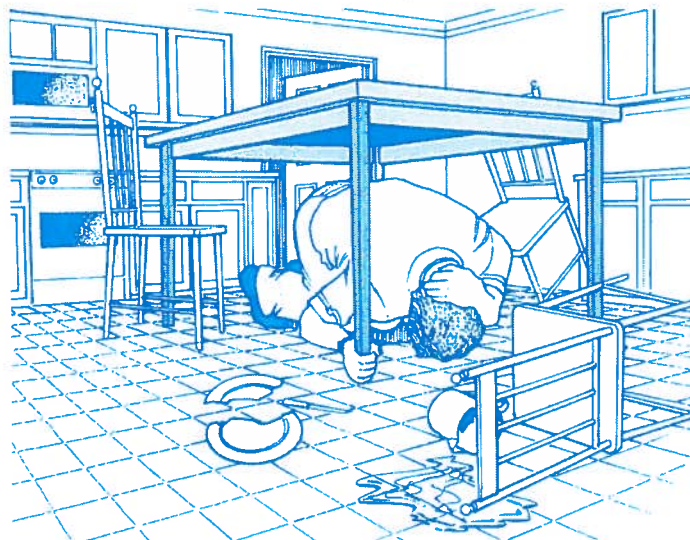

WASHINGTON MILITARY DEPARTMENT  
Emergency Management Division  
Camp Murray, WA 98430-5122

Web site [www.emd.wa.gov](http://www.emd.wa.gov)  
253-512-7000 (800) 562-6108

Prepare in a Year

# Fire Safety

**Pre-planning: key to your safety.** When it comes to fire – *be smart!* If the fire is too big for you to handle, immediately get out of the house. Don't stop to gather anything or to do anything. Once you are outside, stay outside. Intense heat and toxic fumes can kill.

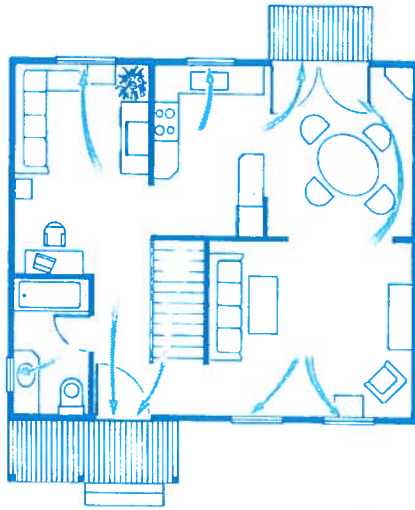

## Planning & practicing fire safety:

1. Choose a reunion place outside your home. Our fire reunion place is:

---



---

- Regularly remind all household members where this place is.

2. Draw the floor plan of your home and discuss two ways to exit each room.
3. Hold a fire drill at least twice each year. Blindfolded, practice crawling your exit routes to simulate getting out of a smoke-filled house.

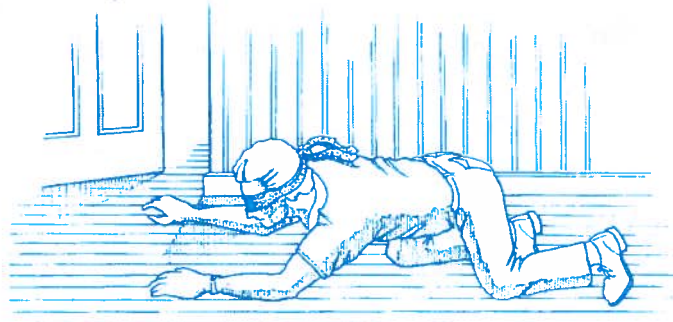

## Fire extinguishers:

- Locate your fire extinguishers with care. Ready access to them is critical. Fire moves quickly – quick access can be the difference between putting a small fire out or suffering much damage.
- Several smaller extinguishers located throughout the house are better than one large one that may be difficult to get to quickly.
- Key places for your extinguishers are:
  - the kitchen
  - the garage
  - one on every level if your home has multiple floors

## ABC extinguishers are recommended:

### "A" fires:

Ordinary combustibles such as wood, paper, cloth, and many plastics.

### "B" fires:

Flammable liquids such as gasoline, paints, kitchen grease, and oils.

### "C" fires:

Electrical equipment such as fires in wiring, motors, and appliances.



*Check your extinguishers on a regular basis to ensure they are properly charged.*



WASHINGTON MILITARY DEPARTMENT  
Emergency Management Division  
Camp Murray, WA 98430 5122

Web site [www.emd.wa.gov](http://www.emd.wa.gov)  
253-512-7000 (800) 562-6108

# Fire Safety - cont.

Watch the videos:  
[www.emd.wa.gov/preparedness/prepare\\_personal\\_prep\\_video\\_index.shtml](http://www.emd.wa.gov/preparedness/prepare_personal_prep_video_index.shtml)

## Using a fire extinguisher:

- Try to keep calm.
- VITAL: Keep an escape route open between you and the *small* fire you are attempting to extinguish. If the fire is large or becomes too large, immediately get out of the house.
- Close the door on your way out to slow the spread of flames.
- Always point the extinguisher at the base of the fire rather than at the top of the flames. Remember, if the fire is too big for you to handle, immediately get yourself and your family out of the house. Don't stop to gather anything or to do anything. Seconds can make all the difference.
- Once you are outside, stay outside. Intense heat and toxic fumes can kill you in seconds.

## Possible fires following earthquakes:

- **Natural gas fires –**  
 First, shut off the gas.  
 Second, put the fire out by using an extinguisher, dirt, or water.
- **Electrical fires –**  
 First, shut off the electricity.  
 Second, put out the fire by using an extinguisher, dirt, or water.  
 (CAUTION: If the electricity cannot be shut off, DO NOT use water on the fire.)
- **Oil or grease fires –**  
 Use baking soda, a lid, a bread board, or a fire extinguisher to smother the flames.  
 NEVER use water on a grease or an oil fire.

## P.A.S.S. - a proven and effective system for putting out fires

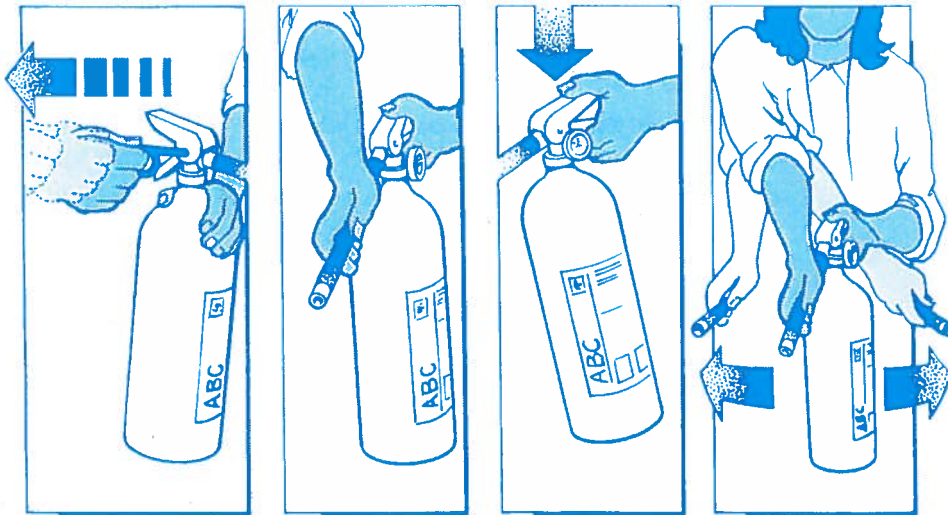

**P. Pull the pin.**

**A. Aim at the base of the fire.**

**S. Squeeze the handle.**

**S. Sweep the hose side to side.**



WASHINGTON MILITARY DEPARTMENT  
 Emergency Management Division  
 Camp Murray, WA 98430-5122

Web site: [www.emd.wa.gov](http://www.emd.wa.gov)  
 253-512-7000 (800) 562-6108

Prepare in a Year



# Shelter-in-Place

## Why:

Your house provides a good first-layer barrier against chemical airborne agents. Additional protection is achieved by tightly sealing one room of your home that you have pre-designated and prepared.

## What:

A safe room is one that easily and quickly can be sealed to protect you from airborne agents, and that has a few supplies to get you through the hours that you will need to stay inside it. All doors and windows of that room will be sealed with plastic sheeting and tape and dampened towels or cloths will be placed under the doors.

**You will probably need to stay inside several hours, but not several days.** So, choose a room that can accommodate your needs for several hours. A master bedroom with an attached bathroom is ideal to give you access to the toilet and running water.

## Preparing a Safe Room:

- Choose one room of your home that you can tightly seal.
- Purchase plastic sheeting and cloth tape or duct tape.
- Pre-cut the plastic to fit all windows, vents, and doors of this room, and label each piece.
- Create a box or container to hold the pre-cut plastic, tape, and these additional supplies: a battery-powered AM / FM radio (power may be out), extra batteries, some snack foods, some water, and some towels and blankets (if this is another room than the bedroom). Store this box in your safe room.

## If in your car:

- Tightly roll up all windows.
- Shut off the motor to avoid drawing outside air in through the engine.
- Turn off all heating and cooling and close all vents.
- Breathe through a dampened cloth.
- Turn on the radio and listen for instructions.



## Generally:

- Shelter where you are unless directed otherwise by response officials.
- It is only natural to want to be with your loved ones, but it is safer to stay where you are. Do not attempt to get your children from school or daycare.
- Typically, events of this type do not last long. The hazardous agents are moved about by air and wind, which is constantly circulating.
- In extreme cases of contamination, breathing through a wet cloth provides additional protection.

*If a chemical agent attack happens, authorities will instruct people to either to seek shelter where they are and seal the premises (shelter-in-place) or evacuate immediately.*



WASHINGTON MILITARY DEPARTMENT  
Emergency Management Division  
Camp Murray, WA 98430-5122

Web site [www.emd.wa.gov](http://www.emd.wa.gov)  
253-512-7000 (800) 562-6108

# Shelter-in-Place Instructions

## 1. Go inside immediately.

- Remember your pets.

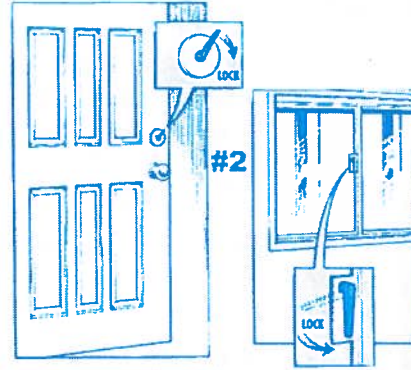

## 2. Tightly lock all doors & windows.

- The more immediately you do this - and the more tightly - the less likely it will be that contaminants will get inside.

## 3. Shut off fans & devices that circulate air throughout your home.

- Shut off fans.
- Adjust the thermostat of furnaces & air conditioners to shut off and stay off.
- Tightly close woodstove & fireplace dampers.
- If a fire is lit, put it out, close the damper, shut the vents and doors.

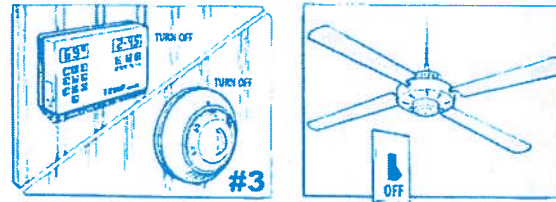

## 4. Go into your pre-selected room & seal it tightly.

- Tape plastic sheeting over windows, doors, vents, bathroom fans, electrical outlets, phone jacks, and TV & cable outlets. Remember - you are creating a tightly sealed room, so freely use the tape.
- Place dampened towels under door cracks to tightly seal them.



## 5. Listen to the radio for instructions.

- Officials will be giving instructions about whether or not to evacuate, and when it is safe to come out.



## 6. Thoroughly air out your home once the emergency is over.

- Open all your doors and windows. This will allow small particles that may have gotten in to dissipate.

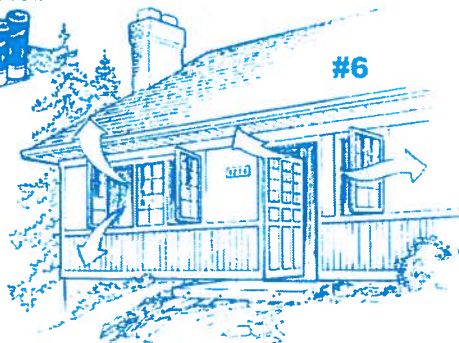

# Home Hazard Hunt

All of Washington State has the potential of being impacted by major disasters such as earthquakes. Earthquakes strike suddenly and without warning. When they occur, they cause the ground to undulate and shake, perhaps violently. Buildings - and their contents - are vulnerable to this rocking and rolling. Fortunately, experts teach how to secure homes to their foundations and contents

## Identifying potential home hazards:

Take 30 minutes to walk through your home. Imagine the ground movement of a significant earthquake. Identify potential hazards by completing this worksheet.



- Check your water heater. Is it securely fastened to the wall studs with heavy-metal strapping at the top and bottom? Not metal plumber's tape.

Yes  No

Does your water heater have flexible water and gas connectors?

Yes  No

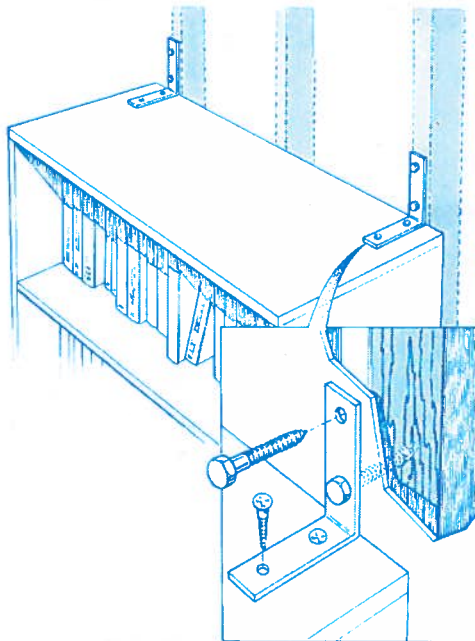

- Tall pieces of furniture are especially vulnerable in earthquakes. Identify each bookcase, china hutch, and armoire which needs fastening.

---



---



---

- Identify heavy or breakable objects on high shelves. Pay special attention to objects with sentimental value. Move heavy objects to lower shelves.

---



---



---

- Identify computers, stereos, televisions, microwaves and other small appliances that need to be secured.

---



---



---

See the section titled Home Preparedness - Getting Ready for ideas on how to secure your tall pieces of furniture costly and valuable items, hanging plants and objects, artwork, and cabinets.

Watch the videos:  
[www.emd.wa.gov/preparedness/prep\\_personal\\_prep\\_video\\_index.shtml](http://www.emd.wa.gov/preparedness/prep_personal_prep_video_index.shtml)



WASHINGTON MILITARY DEPARTMENT  
 Emergency Management Division  
 Camp Murray, WA 98430-5122

Web site [www.emd.wa.gov](http://www.emd.wa.gov)  
 253-512-7000 (800) 562-6108

# Home Hazard Hunt - cont.

Watch the videos:  
[www.emd.wa.gov/preparedness/prep\\_personal\\_prep\\_video\\_index.shtml](http://www.emd.wa.gov/preparedness/prep_personal_prep_video_index.shtml)

- Identify hanging plants, especially heavy baskets, and hanging lights near windows.

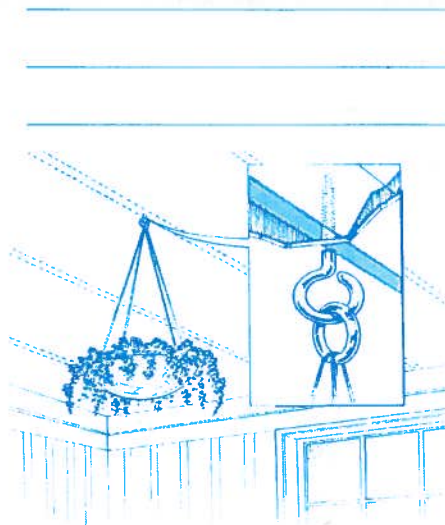

- Identify mirrors, heavily-framed pictures, and framed artwork that needs to be secured to the wall studs. Pay special attention to items hung over beds.

---

---

---

---

---

---

---

---

- Identify kitchen, bedroom, and garage cabinets that need to be secured to keep their contents inside during the ground shaking.

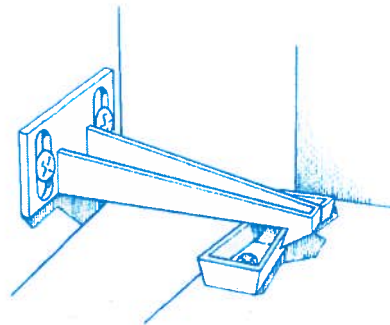

- Inspect the foundation of your home. Is your home securely fastened to it? Check with your local city office which issues building permits for regulations.

Yes  No

Does your chimney have loose bricks?

Yes  No

- Has your attic been reinforced with plywood to help prevent chimney bricks from falling into living areas?

Yes  No

- Identify poisons, toxics, or solvents in breakable containers that are located in high or dangerous locations

---

---

---

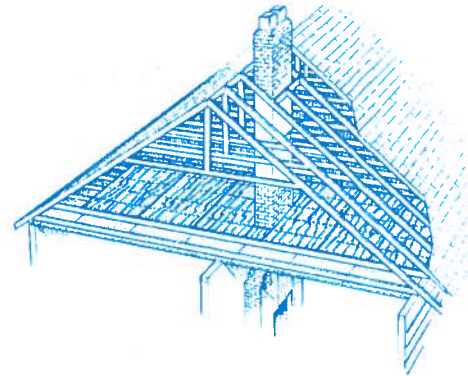

*See the next section titled Home Preparedness - Getting Ready for ideas on how to secure your tall pieces of furniture costly and valuable items, hanging plants and objects, artwork, and cabinets. This section also includes methods to reinforce your attic and suggestions on separating dangerous chemicals and securing them to prevent spills.*



WASHINGTON MILITARY DEPARTMENT  
Emergency Management Division  
Camp Murray WA 98430-5122

Web site [www.emd.wa.gov](http://www.emd.wa.gov)  
253-512-7000, (800) 562-6108

Prepare in a Year



# Secure Wall Hangings

“How to” videos: [www.emd.wa.gov/preparedness/prep\\_personal\\_prep\\_video\\_index.shtml](http://www.emd.wa.gov/preparedness/prep_personal_prep_video_index.shtml)

## Framed pictures - securing them helps prevent cut feet:

The ground swells and rolls of major earthquakes easily can knock heavy pictures and mirrors off the walls. This can be especially dangerous in the night if these unsecured items are located close to your bed or during the day if they are located close to your favorite chair or sofa.

Cut feet from broken framing glass and mirrors is one of the most common injuries resulting from major earthquakes. Securing your pictures helps prevent this common injury.

*Screw hook into wall, leaving just enough space to slide the wire onto the hook.*

*Secure the bottom corners of these items with Quake-Hold™ - type products*

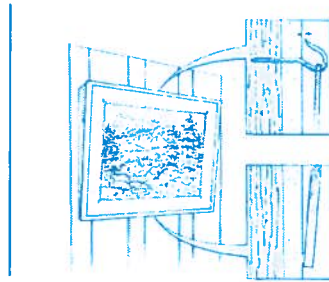

## Securing artwork, pictures, and mirrors:

- Use a stud finder to find the closest wall stud.
- Screw a screw hook into the wall stud so that there is barely enough room to slide the framing wired between the wall and the hook. This will help prevent the wire from jumping off the hook during potentially violent movement of an earthquake.
- If the artwork or mirror is large and/or heavy, you may want to consider securing it to two wall studs.
- Secure the bottom corners of these items with Quake-Hold™ - type products to keep them from banging against the wall. This helps keep the framing glass from breaking and damaging the artwork or photo.

## Securing hanging objects:

Carefully check the location of all hanging plants and other objects. Determine if these objects are close enough to windows to strike them in the wild motion of an earthquake. If they are, consider moving them.

- Find the ceiling stud by using a stud finder.

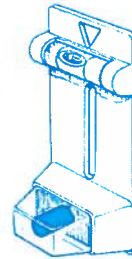

*Example of a stud finder*

- Screw the hook directly into the ceiling stud.
- Hang the object from this hook.
- Close the opening in the hook with a pair of pliers to prevent the object from leaping off the hook during an earthquake.



WASHINGTON MILITARY DEPARTMENT  
Emergency Management Division  
Camp Murray WA 98430-5122

Web site [www.emd.wa.gov](http://www.emd.wa.gov)  
253-512 7000 (800) 562 6108

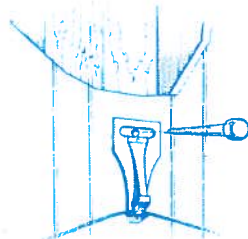

*Picture hanging hooks that actually close are also a good choice for securing pictures.*





# Secure Tall Furniture

“How to” videos: [www.emd.wa.gov/preparedness/ prep\\_personal\\_prep\\_video\\_index.shtml](http://www.emd.wa.gov/preparedness/prep_personal_prep_video_index.shtml)

## Earthquakes: A Sudden Release of Energy:

The forces that create earthquakes cause the earth to literally to quake producing:

- Ground rolling and undulating, from a few inches to a few feet in height.
- Ground shaking, from a few seconds to a few minutes in duration.

Tall pieces of furniture such as bookcases, china hutches, and armoires are very likely to fall when the ground is rolling and shaking. You can prevent them from falling on someone you care about and save their contents by completing these simple steps.

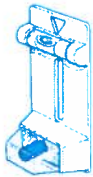

Example of a stud finder

## Securing bookcases and all things tall:

1. Secure the furniture item into the wall stud.
  - Locate the wall studs using a stud finder.
  - Secure each furniture piece to at least two wall studs, depending on the size and with, using 4” L-brackets and 3” lag screws, available at all hardware stores.
  - There are commercially available kits utilizing nylon strapping that also are recommended.

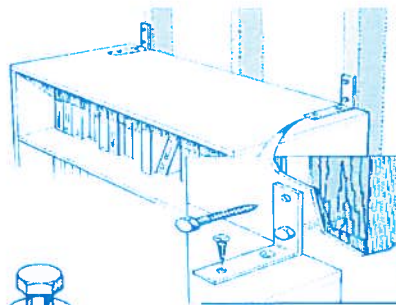

*There are commercially available kits utilizing nylon strapping that also are recommended.*

2. Place heavy and/or large items on lower shelves to prevent them from flying around the room.

3. The ground swells and rolls of an earthquake can cause anything resting on shelves or counter tops to fall - TVs, stereos, computers, microwaves, lamps, etc. An easy way to protect against these types of losses is to use Velcro™ or other similar products.
  - Choose a Velcro™-type product that has adhesive on the back.
  - Cut the Velcro™ into large squares. You will need four squares to secure most items, one for each leg or corner of the items.
  - Press the two sides of the Velcro™ together.
  - Remove the paper from the backs of the Velcro™ to expose the adhesive.
  - With the Velcro™ still pressed together, stick it on the legs or corners of the item, and then place the item on the shelf or counter top where you want it located.

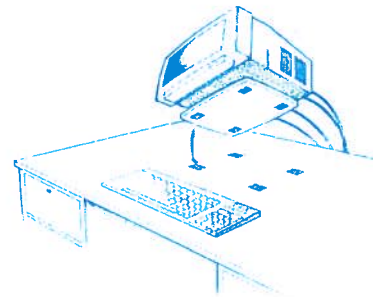

4. More delicate items, like knickknacks, pottery, crystal vases, etc. can be secured with products like quake Hold™ or Museum Wax™, available at many hardware stores.



Home Preparedness  
Getting Ready



WASHINGTON MILITARY DEPARTMENT  
Emergency Management Division  
Camp Murray WA 98430-5122

Web site [www.emd.wa.gov](http://www.emd.wa.gov)  
253-512-7000, (800) 562-6108



# Kitchen & Cabinet Safety

“How to” videos: [www.emd.wa.gov/preparedness/rep\\_personal\\_prep\\_video\\_index.shtml](http://www.emd.wa.gov/preparedness/rep_personal_prep_video_index.shtml)

## Kitchen Cabinets:

The ground undulation and acceleration of an earthquake can cause cabinet doors to fly open and contents to spill onto the floor. Glass jars and dishes can shatter and cause injuries and damage. Heavy objects can fly across the room, injuring anyone in their path or damaging counter tops, floors, or walls.

## Securing Kitchen Cabinets:

To prevent cabinet doors from flying open, install one of the following types of latches:

- A. Hook and eye - inexpensive; you may not close it every time.
- B. Standard latch - mounts to the front of the door; you may not close it every time.
- C. Standard latch - closes automatically; mounts to the front of the door.
- D. Push latches - mounts inside the door; holds the door firmly shut; opens by being gently pushed inward.

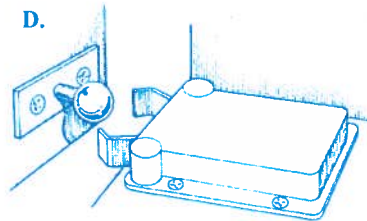

- E. Child-proof - inexpensive; closes automatically; require an extra action when you open the door; takes some getting used to.

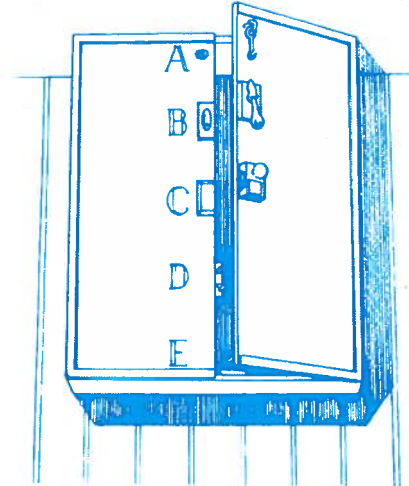
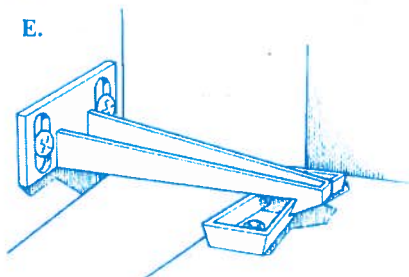

## Securing Cabinet Contents:

The contents of cabinets may shift and break in the movement of an earthquake. To help prevent this movement, line your cabinets with rubberized shelf mats. This typically is sold in rolls or pre-cut squares at hardware and variety stores. It is also available at recreational vehicle or boating equipment supply stores.

To **protect stacked china plates**, place a square of this rubberized matting between each plate in the stack.

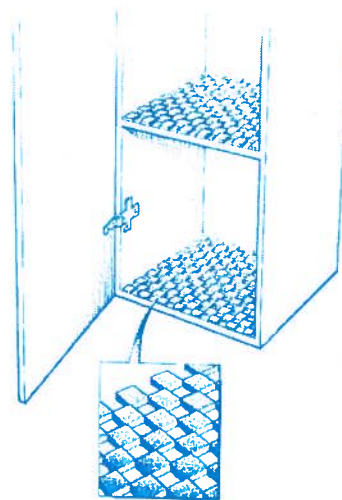

WASHINGTON MILITARY DEPARTMENT  
Emergency Management Division  
Camp Murray, WA 98430-5122

Web site: [www.emd.wa.gov](http://www.emd.wa.gov)  
253-512-7000 (800) 562-6108

Home Preparedness  
Getting Ready



# Securing the Water Heater

“How to” videos: [www.emd.wa.gov/preparedness/prep\\_personal\\_prep\\_video\\_index.shtml](http://www.emd.wa.gov/preparedness/prep_personal_prep_video_index.shtml)

## Protected source of water - or a puddle:

Fresh water after a disaster may be as close as your water heater - provided, of course, that it remains standing upright. A typical water heater holds 30-50 gallons of water.

However, this supply of water is extremely vulnerable to the ground undulation (swells and rolls) and ground acceleration of earthquakes, causing them to tip over.

You can protect this valuable resource by securing your water heater to the wall studs.

*Water heaters are an excellent supply of emergency water; water can be accessed from the drain spout.*

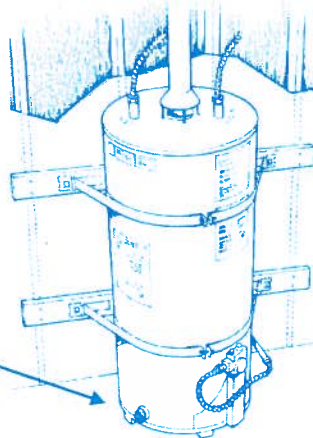

## Secure your water heater:

There should be very little space between the water heater and the wall. If there is a more than 1 or 2 inches, attach a wooden block to the wall studs with long lag screws. The purpose is to prevent the tank from tipping backwards.

Wrap the heavy-gauge metal strapping 1 1/2 times around the tank. Start by placing the strapping at the back of the tank, bring it to the front and then take it back to the back wall.

Secure this strapping to the wall studs of the wood block using several 1/4 " x 3" or long lag screws with oversized washers. If you are securing it directly into concrete use 1/4" expansion bolts in place of the screws.

*Commercially available kits like this one come*

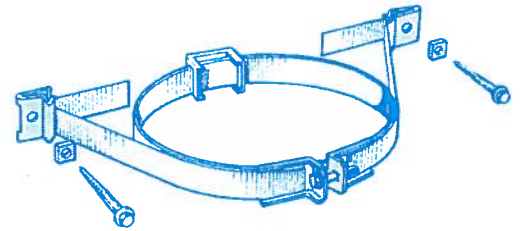

*complete with strapping, lag screws, washers, spacers, and tension bolts. These kits can be purchased at many local hardware stores and are recommended.*

## Changes to strapping recommendations:

Experts have modified the recommended procedure for strapping water heaters because many tanks burst through their strapping in both the 1989 Loma Prieta (San Francisco) and the 1994 Northridge (Los Angeles) earthquakes. Experts recommend these two important changes.

1. Secure both the top and bottom of the hot water tank, not just the top or just the middle.
2. Use heavy-gauge metal strapping rather than plumber's tape. Many water heaters in both the 1989 and the 1994 earthquakes burst through the plumber's tape that was intended to keep them secure. Plumber's tape has been found to be too brittle to be effective.

## Note

- Replace all copper and metal piping with flexible natural gas and water line connectors.



WASHINGTON MILITARY DEPARTMENT  
Emergency Management Division  
Camp Murray WA 98430-5122

Web site [www.emd.wa.gov](http://www.emd.wa.gov)  
253-512-7000 (800) 562-6108



***Do NOT use this - this is plumber's tape.  
Use heavy-gauge strapping instead.***

Home Preparedness  
Getting Ready



# Garage & Storage Safety

“How to” videos: [www.emd.wa.gov/preparedness/rep\\_personal\\_prep\\_video\\_index.shtml](http://www.emd.wa.gov/preparedness/rep_personal_prep_video_index.shtml)

## Household Chemicals - potentially lethal:

The ground movement of earthquakes can cause the chemical products you have stored in the garage and under household sinks to spill and potentially mix. These materials can be silent killers or can cause serious injury.

## Before a disaster - secure all chemicals:

Secure all chemicals so they cannot fall, break, and mix.

- Identify poisons, toxins, and solvents in breakable containers on open shelves.
- Remove all heavy objects from upper shelves, especially around the car.
- Secure open shelves with nylon webbing (available at hardware stores, boating supply stores, and many camping supply stores) or bungee straps. *(Do not use the regular bungee straps with the heavy metal hooks at either end. These may become dislodged and cause serious eye or other injuries.)*
- Store paints, gasoline, and other flammable liquids away from natural gas water heaters.
- Read the labels on all products you purchase.
- Separate the chemicals according to manufacturer's suggestions to prevent harmful interactions if broken containers allow the chemicals to mix. For example, household bleach mixed with ammonia creates extremely deadly chlorine gas.
- Know what steps to take if chemicals are spilled.
- Dispose of any hazardous materials that are no longer used.

## After a disaster - safety with chemicals:

- Always assume that spilled chemicals are toxic.
- Do not immediately approach spilled chemicals in your haste to clean them up. Mixed chemicals can be extremely hazardous.
- Close off the room where the spill has occurred.
- Mark the outside of the room with the problem, for example, “spilled chemicals inside - use caution.”
- As soon as possible, notify the fire department that you have a chemical spill.

## Ways hazardous materials enter the body:

- Inhalation (breathing) - the most common way.
- Absorption - through skin or eyes.
- Ingestion - swallowing.
- Injection - penetrating the skin or falling on something that punctures the skin.

## Indicators that a spill has taken place:

- Pungent or noxious odor - never intentionally get close enough to smell it.
- Bubbling liquid.
- Vapor - anything that is releasing a vapor is having a chemical reaction and should be avoided.

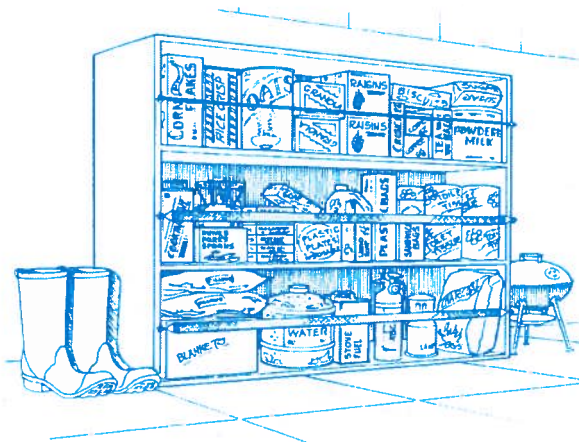

WASHINGTON MILITARY DEPARTMENT  
Emergency Management Division  
Camp Murray, WA 98430 5122

Web site [www.emd.wa.gov](http://www.emd.wa.gov)  
253-512-7000 (800) 562-6108

Home Preparedness  
Getting Ready



# Structural Mitigation

“How to” videos: [www.emd.wa.gov/preparedness/prep\\_personal\\_prep\\_video\\_index.shtml](http://www.emd.wa.gov/preparedness/prep_personal_prep_video_index.shtml)

## Wood-Framed Homes - safe & sound?

Homes that have been framed in wood are generally quite resistant to earthquake damage. While it is unlikely that conventionally framed houses will collapse, your assurances of safety are dramatically improved if the home remains on its foundation, and the roof, ceiling, and walls remain connected. If you have specific questions about your home, please contact an engineer experienced in seismic strengthening.

**Caution:** Retrofitting done improperly may actually cause damage to your home during an earthquake.

These pages are intended to illustrate the types of structural retrofitting houses need to be seismically safe. They are **NOT** intended to provide the specific directions on how to do the retrofitting.

Check with your local office responsible for issuing building permits for complete instructions.

## Securing your Foundation:

The majority of residential structural damage is caused by homes sliding off their foundations during major earthquakes.

- Check your house and garage for foundation bolts. These bolts secure the wood structure to the concrete foundation. They should be placed every six feet along the sill plate.
- Using a hammer drill and a carbide bit, drill a hole through the sill plate into the foundation. Place these holes every six feet.
- Drop a 1/2" x 8" expansion bolt into the hole and tighten the nut.

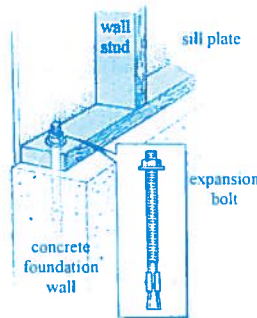

## Cripple Walls:

- Inspect the vertical studs that extend from the foundation to the first floor of your home. These are common in crawl space areas and are called cripple walls. If they are exposed (for example, without sheathing) on the inside, they could buckle in the ground motion that accompanies many large earthquakes.
- Strengthen the cripple walls by nailing plywood sheathing to the vertical studs, sill plate, and top plate.

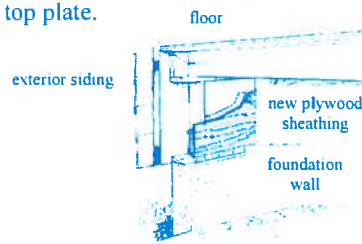

## Strengthening the Frame Body:

For a building to stay together in an earthquake, all its parts must be fastened together. Commercially available metal connectors are used to strengthen places where beams, posts, wall, the floor and the ceiling join..

- Strengthen the connections between ceilings, walls, and floors using the appropriate hardware.
- Inspect all exposed framing in garages, basements, porches, and patio covers. Strengthen this where necessary.



## Brick & Masonry Facades:

- Check all brick, masonry, and stone facades to make sure they are securely attached to your home. Consult a structural engineer for advice on how to do this.

## Chimney:

One of the most common types of damage suffered in earthquakes is a toppled chimney. This becomes extremely dangerous when bricks penetrate the roof and fall to the rooms below.

- Check the chimney for loose tiles and bricks.
- Reinforce the ceiling surrounding the chimney with 3/4" plywood nailed to the beams. This provides protection from falling bricks that might break through the roof.
- If your chimney is old and extends more than five feet above the roof, consider bracing it. Check the yellow pages in the phone book for engineers who are experienced in seismic strengthening.



## Windows:

- Inspect all large plate glass windows to make sure they are safety glass.
- Consider adding a safety film to all windows. This does not prevent the window from breaking, but it does keep the glass from falling and injuring loved ones.



WASHINGTON MILITARY DEPARTMENT  
Emergency Management Division  
Camp Murray WA 98430 5122

Web site: [www.emd.wa.gov](http://www.emd.wa.gov)  
253-512-7000; (800) 562-6108

Home Preparedness  
Getting Ready

# MYN

## Map Your Neighborhood



*- Remember -*  
*In a disaster your most immediate source of help are the neighbors living around you.*



---

## Prepare

Neighborhoods that are prepared for emergencies and disaster situations save lives, reduce the severity of injuries and trauma, and reduce property damage. In addition, contributing as an individual and working together as a team helps develop stronger communities and improve the quality of life in the community.

---

## Learn

- Learn the first **9 Steps to Take Immediately Following a Disaster** to secure your home and protect your neighborhood. It is hard to think clearly following disaster. These steps will help you to quickly and safely take actions that can minimize damage and protect lives.
- Identify the **Skills and Equipment Inventory** each neighbor has that are useful in an effective disaster response. Knowing which neighbors have supplies and skills ensures a timely response to a disaster and allows everyone to contribute to the response in a meaningful way.
- Create a **Neighborhood Map** identifying the locations of natural gas and propane tanks for quick response if needed.
- Create a **Neighborhood Contact List** that identifies those with specific needs such as the elderly, those with a disability, or homes where children may be alone during certain hours of the day.
- Work together as a team to evaluate your neighborhood after a disaster and take the necessary actions.

---

Washington State Emergency Management Division, Public Education Program  
Bldg. 20 MS; TA-20 Camp Murray, WA 98430  
1.800.562.6108 [PublicEducation@emd.wa.gov](mailto:PublicEducation@emd.wa.gov); [www.emd.wa.gov/myn](http://www.emd.wa.gov/myn)

---

The Map Your Neighborhood Program (MYN) was developed and copyrighted by © LuAn K Johnson, PhD.  
Used with permission from WA State Emergency Management Public Education Program.

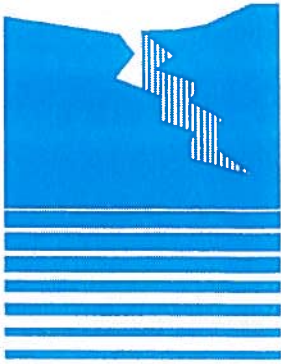

# Earthquakes

Washington State is Earthquake Country. When you feel the ground begin to shake  
**DROP, COVER AND HOLD ON!**

**Do NOT run!**

## Be prepared for an earthquake:

- Prepare disaster kits for your home, workplace, and vehicle.
- Establish an “out-of-area” contact and keep the phone number handy. This is the person family members will call if you are separated.
- Know what emergency plans are in place at your work, school, and daycare.
- Find out who in your area might need special assistance: elderly, disabled, or non-English speaking neighbors.
- Check with your veterinarian for animal care instructions in an emergency.
- Conduct a home hazard evaluation to determine what can be done to improve your home to protect it against earthquake damage.

See the *Prepare in a Year* and the *Home Preparedness* sections of this booklet.

## During an earthquake:

- If you are **indoors**, stay inside. Move under a desk or sturdy table and hold on to it. If it moves, move with it. Stay away from windows, bookcases, refrigerators, heavy mirrors, hanging plants and other objects that could fall. Do not go outside until the shaking stops.
- If you are in a **crowded store or public place**, do not rush for an exit. Move away from display shelves holding objects that could fall on you, and “drop, cover, and hold on.”
- If you are in a **theater or stadium**, stay in your seat, protect your head with your arms or get under the seat. Do not leave until the shaking stops.

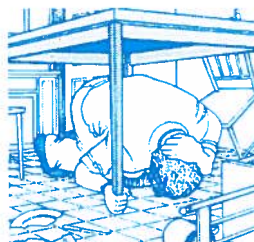

- If you are **outdoors**, move to a clear area away from trees, signs, buildings or downed electrical wires and poles.
- If you are on a **sidewalk near a tall building**, get into a building’s doorway or lobby to protect yourself from falling bricks, glass, and other debris.
- If you are **driving**, slowly pull over to the side of the road and stop. Avoid overpasses, power lines and other hazards. Stay inside the vehicle until the shaking stops.
- If you are in a **wheelchair**, stay in it. Move to safe cover if possible, lock your wheels, and protect your head with your arms.



## After the earthquake:

- Be prepared for aftershocks.
- Check yourself and those around you for injuries.
- Call 9-1-1 only to report a life-threatening emergency.
- Try to contact your out-of-area phone contact.
- Listen to your radio.
- If you were evacuated, wait until you are told it is safe before returning home or going back inside.
- Stay away from downed power lines.
- Do not drive unnecessarily.
- If you smell gas or hear a hissing sound - open a window and leave the building. Shut off the main gas valve outside.
- Check on neighbors, particularly elderly or disabled persons.



WASHINGTON MILITARY DEPARTMENT  
Emergency Management Division  
Camp Murray, WA 98430-5122

Web site [www.emd.wa.gov](http://www.emd.wa.gov)  
253-512-7000, (800) 562-6108

**DROP, COVER & HOLD ON!**



# Floods

**Floods are the most common and widespread of all natural disasters. Take preparedness action now to minimize your risk and reduce the time and effort it takes to recover from a flood.**

## What to do before a flood

- Call your local building department or office of emergency management for information.
- Listen to your radio or television for reports of flood danger.
- Plan for evacuation including where you are going to go and the route you will follow.
- Purchase flood insurance.
- Keep all insurance policies and a list of valuable items in a safe place.
- Take photos or a videotape of your valuables you keep in your home.
- Keep your car filled with gas.

## What to do during a flood

- Do not try to walk or drive through flooded areas. Water can be deeper than it appears and water levels rise quickly. Follow official emergency evacuation routes. If your car stalls in floodwater get out quickly and move to higher ground.
- Stay away from moving water; moving water six inches deep can sweep you off your feet. Cars are easily swept away in just two feet of water.
- Stay away from disaster areas unless authorities ask for volunteers.
- Stay away from downed power lines.
- If your home is flooded, turn the utilities off until emergency officials tell you that it is safe to turn them on. Do not pump the basement out until floodwater recedes. Avoid weakened floors, walls, and rooftops.
- Wash your hands frequently with soap and clean water if you come in contact with floodwaters.

## What to do after a flood

- Wear gloves and boots when cleaning up.
- Open all doors and windows. Use fans if possible to air out the building.
- Wash all clothes and linens in hot water.
- Discard mattresses and stuffed furniture; they can't be adequately cleaned.
- Wash dirt and mud from walls, counters, and hard surfaced floors with soap and water. Disinfect by wiping surfaces with a solution of one cup bleach per gallon water.
- Discard all food that has come into contact with floodwater. Canned food is alright, but thoroughly wash the can before opening.
- If your well is flooded, your tap water is probably unsafe. If you have public water, the health department will let you know - through radio and television - if your water is not safe to drink. Until your water is safe, use clean bottled water.
- Learn how to purify water. If you have a well, learn how to decontaminate it. (see pages 3-4)
- Do not use your septic system when water is standing on the ground around it. The ground below will not absorb water from sinks or toilets. When the soil has dried, it is probably safe to again use your septic system. To be sure, contact your local health department.
- When floodwaters have receded watch out for weakened road surfaces.



WASHINGTON MILITARY DEPARTMENT  
Emergency Management Division  
Camp Murray WA 98430-5122

Web site [www.emd.wa.gov](http://www.emd.wa.gov)  
253 512 7000 (800) 562 6108





# Landslides and Mud Flows

Landslides and mudflows usually strike without warning. The force of rocks, soil, or other debris moving down a slope can devastate anything in its path.

## Before a landslide:

- Contact your county geologist or county planning department, they may have specific information on areas vulnerable to landslides. Consult a professional geotechnical expert for advice on corrective measures you can take.

## Minimize home hazards:

- Plant ground cover on slopes to stabilize the land and build retaining walls. Get expert advice in selecting the best ground cover for your area.
- Build channels or deflection walls to direct the flow around buildings.

*Remember: If you build walls to divert debris flow and the flow lands on a neighbor's property, you may be liable for damages.*

## Make evacuation plans:

- Plan at least two evacuation routes since roads may become blocked or closed.

## Purchase Insurance:

- Mudflow is covered by flood insurance policies from the *National Flood Insurance Program*. Flood insurance can be purchased through a local insurance agency.

## Learn to recognize the landslide warning signs:

- Doors or windows seem to stick or jam for the first time.
- New cracks appear in plaster, tile, brick, or foundations.
- Outside walls, walks or stairs begin pulling away from the building.
- Slowly developing, widening cracks appear on the ground or on paved areas.
- The ground slopes downward in one specific direction and may begin shifting in that direction under your feet.
- Bulging ground appears at the base of a slope.
- Water breaks through ground surface.
- Fences, retaining walls, utility poles, or trees tilt or move.
- Underground utility lines break.

## During a landslide:

### • If inside a building:

- Stay inside.
- Take cover under a desk, table, or other piece of sturdy furniture.

### • If outdoors:

- Run to the nearest high ground in a direction away from the path.
- If rocks and other debris are approaching, run for the nearest shelter such as a group of trees or a building.
- If escape is not possible, curl into a tight ball and protect your head.

## After a landslide:

- Remember that flooding may occur after a mudflow or a landslide.
- Stay away from the immediate slide areas; there may be danger of additional slides.
- Check for injured and trapped persons near the slide area. Give first aid. Call 9-1-1 if there are life-threatening injuries.
- Remember to help your neighbors who may require special assistance —infants, elderly people, and people with disabilities.
- Listen to a battery-operated radio or television for emergency information.
- Check for damaged utility lines. Report damage to the utility company.
- Check the building foundations, chimney, and surrounding land for damage.
- Replant damaged ground as soon as possible. Erosion caused by loss of ground cover can lead to flash flooding.



WASHINGTON MILITARY DEPARTMENT  
Emergency Management Division  
Camp Murray WA 98430-5122

Web site [www.emd.wa.gov](http://www.emd.wa.gov)  
253-512-7000 (800) 562-6108



# Tsunamis

A tsunami is a series of destructive waves affecting shorelines. Tsunamis are usually generated by earthquakes. Tsunamis may also be caused by underwater landslides or underwater volcanic eruptions.

## Tsunami dangers:

- Tsunami waves can be created by events thousands of miles from beaches.
- Tsunami waves can be as tall as 30 feet when they come ashore; 60 feet in extreme cases. They can move inland from several hundred feet to several miles.
- A tsunami can cause a series of waves that arrive over several hours. Later waves can be larger than the first wave.
- Tsunamis move faster than a person can run.
- Tsunamis have enormous power - enough to move rocks weighing several tons, boats, and other debris. Homes and other buildings can be destroyed. People can be killed or injured by the force of the water.

## What to do at the beach:

Immediately head for higher ground: do not wait for a warning if:

- The ground shakes...run to high ground.
- You hear a siren...run to high ground.
- The ocean recedes dramatically from the shoreline...run to high ground.

## Follow the tsunami evacuation signs:

- Tsunami evacuation route signs have been placed along coastal roadways to indicate the direction inland or to higher ground. In some places, there may be more than one route to safer areas. These routes may be marked with several signs showing you additional options for evacuation. You should know the evacuations routes for your area.

## Tsunami definitions:

The National Oceanic and Atmospheric Administration (NOAA) can issue an official tsunami alert within minutes after an earthquake.

## Tsunami Warning:

- A warning is issued when a tsunami with potential significant widespread flooding is imminent or expected.
- Move to higher ground or inland - immediately.
- If no higher ground is nearby, go to upper levels of reinforced buildings.
- Continue to monitor your local radio and NOAA Weather Radio for further information.

## Tsunami Advisory:

- An advisory reports a threat of a tsunami that may produce strong currents or waves dangerous to those in or near the water.
- Stay away from beaches, ports, and harbors and listen to your radio, NOAA Weather Radio, or TV for updates.
- Know well in advance what your safest evacuation route will be.
- Local officials will determine appropriate actions such as closing beaches, evacuating people, repositioning ships, etc.

## Tsunami Watch:

- A tsunami watch is issued about events that may later impact the area. The watch may be updated to a warning or advisory - or cancelled.
- Listen to your radio, NOAA Weather Radio, or TV for updates.
- Know well in advance what your safest evacuation route will be.



WASHINGTON MILITARY DEPARTMENT  
Emergency Management Division  
Camp Murray WA 98430 5122

Web site [www.emd.wa.gov](http://www.emd.wa.gov)  
253-512-7000 (800) 562-6108



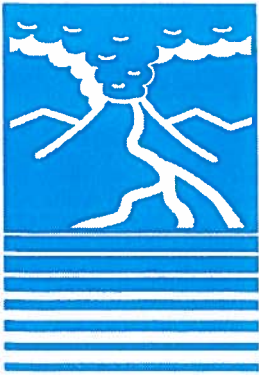

# Volcanoes

Volcanic dangers include not only an eruption of a mountain and associated lava flows, but also ash fall and debris flows.

If you are near a mountain range, be familiar with your evacuation routes.

## Before a Volcanic Eruption:

- Plan ahead. Have emergency supplies, food, and water stored.
- Plan an evacuation route away from rivers or streams that may carry mud or debris flow.
- Keep a battery-operated/wind-up radio available at all times. Have extra batteries.
- If there is an eruption predicted, monitor the radio or TV for evacuation information. Follow the advice given by authorities.

## After a Volcanic Eruption:

- Do not approach the eruption area.
- Be prepared to stay indoors and avoid downwind areas if ash fall is predicted.
- Evacuate if ordered to do so by authorities.
- Be aware of stream and river channels when evacuating.
- Move toward higher ground if mudflows are approaching.
- Follow the evacuation signed posted along roads and highways.



## If there is Ash Fall in Your Area:

- Protect your lungs. Infants, the elderly and those who have respiratory conditions such as asthma, bronchitis, emphysema, or other chronic lung and heart disease should be particularly careful to avoid breathing ash.
- Stay inside. Close doors, windows, and dampers. Place damp towels at door thresholds and other draft sources.

- Those most at risk should limit outdoor activities. Keep children and pets indoors.
- When outside, wear a single-use (disposable) facemask. Remember that these mask may not fit small children properly. *Note: Masks may make breathing more difficult for people with respiratory conditions.*
- If you have asthma or another respiratory condition - or have a child with asthma - pay attention to symptoms such as sneezing, coughing, or more severe symptoms such as chest pain or tightness, shortness of breath and severe fatigue. Stay indoors and follow your asthma management plan. Contact your doctor if you have trouble breathing.
- Replace disposable furnace filters or clean permanent furnace filters frequently.
- If you wear contact lenses, protect your eyes by wearing glasses or protective goggles or by removing your contacts.
- If you find ash in your drinking water use an alternate source of drinking water such as purchased bottle water.
- Put stoppers in the tops of your drainpipes.
- Protect dust-sensitive electronics.
- Keep roofs free of ash in excess of four inches.
- Remove outdoor clothing before entering a building.
- Wash vegetables from the garden before eating them.
- Minimize travel - ash may be harmful to your vehicle.
- Frequently change oil and air filters in our automobile.



WASHINGTON MILITARY DEPARTMENT  
Emergency Management Division  
Camp Murray WA 98430-5122

Web site [www.amd.wa.gov](http://www.amd.wa.gov)  
253 512-7000 (800) 562-6108

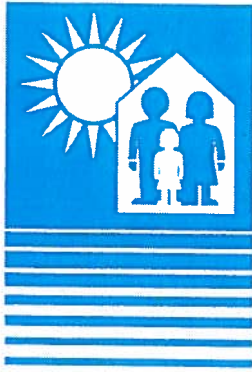

# Hot Weather

Severe heat may cause illness or even death. When temperatures rise to extreme highs, reduce risks by taking the following precautions.

## Hot weather precautions to reduce the risk of heat exhaustion and heat stroke:

- Stay indoors and in an air-conditioned environment as much as possible unless you are sure your body has a high tolerance for heat.
- Cover windows that receive morning or afternoon sun. Awnings or louvers can reduce the heat entering a house by as much as 80 percent.
- Drink plenty of fluids but avoid beverages that contain alcohol, caffeine, or a lot of sugar.
- Eat more frequently but make sure meals are balanced and light.
- Never leave any person or pet in a parked vehicle.
- Make sure pets have plenty of water.
- Avoid dressing babies in heavy clothing or wrapping them in warm blankets.
- Check frequently on people who are elderly, ill or who may need help. If you might need help, arrange to have family, friends, or neighbors check in with you at least twice a day throughout warm weather periods.
- Salt tablets should only be taken if specified by your doctor. If you are on a salt-restrictive diet, check with a doctor before increasing salt intake.
- If you take prescription diuretics, antihistamines, mood-alerting or antispasmodic drugs, check with a doctor about the effects of sun and heat exposure.

## If you go outside:

- Plan strenuous outdoor activities for early or late in the day when temperatures are cooler; then gradually build up tolerance for warmer conditions.
- Wear a wide-brimmed hat, sun block and light-colored, loose-fitting clothes, when outdoors.
- Take frequent breaks when working outdoors.
- At first signs of heat illness (dizziness, nausea, headaches, muscle cramps), move to a cooler location, rest for a few minutes and slowly drink a cool beverage. Seek medical attention immediately if you do not feel better.
- Avoid sunburn: it slows the skin's ability to cool itself. Use a sunscreen lotion with a high SPF (sun protection factor) rating.
- Avoid extreme temperature changes. A cool shower immediately after coming in from hot temperature can result in hypothermia, particularly for elderly or very young people.

## If the power goes out or air conditioning is not available:

- If air conditioning is not available, stay on the lower floor out of the sunshine.
- Ask your doctor about any prescription medication you keep refrigerated. If the power goes out, most medications will be fine to leave in a closed refrigerator for a least three hours.
- Keep a few bottles of water in your freezer; if the power goes out, move them to your refrigerator and keep the doors shut.



WASHINGTON MILITARY DEPARTMENT  
Emergency Management Division  
Camp Murray WA 98430 5122

Web site [www.emd.wa.gov](http://www.emd.wa.gov)  
253-512-7000 (800) 562-6108



# Wildfires

Forest fires and wildfires threaten lives and destroy homes and natural resources. You can take action now that can help save lives and help prevent or reduce damage caused by wildfires.

## What to do before a wildfire:

- Prepare your home for a wildfire. Clearly mark all driveways with names/addresses. Remove firewood, shrubs, and other combustibles away from the home. Call your local fire, forestry, or natural resources office, or go to [www.firewise.org](http://www.firewise.org) for more ideas on home design and landscaping.
- Talk to your neighbors about wildfire safety and working together during a wildfire.
- Always call your local fire department before burning outside or using gas-powered equipment on dry, windy days.
- Be careful when cooking outdoors
- Identify local television and radio stations. They will have the latest information about fires in your area.
- Have an evacuation plan. You may need to leave your home to go to a safe place. Know where you are going and the possible routes to get there.
- Designate a "safety zone" in case all evacuation routes are burning.
- Put together a 72-hour emergency supply kit. Include water, food, protective clothing—sturdy shoes, cotton or wool clothing, long pants, long-sleeved shirts, gloves and a handkerchief. Store in easy-to-carry packs.
- Store copies of your vital records and lists/photos/videotapes of valuable items in a safety deposit box. Include updated insurance policies.
- Make emergency plans for your pets and livestock.
- Family members should have an out-of area contact they can call to let them know they are safe when they are separated. Prepare out of area wallet cards with the contact's information.
- If you have special physical or medical needs, be sure to have an ample supply of medication and supplies to take with you if you evacuate. People with heart and lung disease must be especially careful around wood smoke. Discuss your emergency plans with your medical provider.

## When wildfire threatens:

- Set up a ladder, garden hoses, and sprinklers on the roof. To conserve water, wait until the embers start falling.
- Put on protective clothing to protect your body, face, and lungs.
- Remain calm. Listen to the radio and television for fire reports and evacuation information. Follow the advice given by authorities. (however, if you feel threatened, do not wait to leave.)
- Phone/tell your family and friends you may need to evacuate and let them know where you are going. Use your out-of-area contact card.
- Pre-load your vehicle with emergency supplies, vital records, and other valuables. Face your vehicle in the direction of escape. Keep pets confined nearby.
- Prepare a note to post at your home that tells when you left and where you are going.

## If advised to evacuate, do so immediately:

- If there is time - close all windows, vents, doors, and remove lightweight curtains. Shut off gas utilities.
- Turn on your home's lights.
- Post your preparedness note on the main entrance.
- Lock your doors.
- Choose a route away from fire hazards. Drive with your lights on and watch for emergency vehicles.
- If your evacuation route(s) are burning - go to your designated "safety zone."
- Do not attempt to re-enter the area until firefighters have declared it safe.





# Windstorms

Every fall and winter, windstorms cause extensive damage, including the loss of electricity. By taking action now, you can save lives and reduce the damage caused by windstorms and other weather-related hazards.

## What to do before a windstorm:

- Contact your local emergency management office or the National Weather Service to find out what types of storms are most likely to occur in your community.
- Assemble a disaster supply kit
- If you have a home generator, make sure you know how to use it safely. Follow all instructions and contact the vendor, if necessary. Improper use of a generator can cause carbon monoxide poisoning.
- Find out who in your area might need special assistance, such as the elderly, disabled, non-English speaking neighbors.
- Check with your veterinarian for animal care instructions in a emergency situation.
- Know what emergency plans are in place at your workplace, school, and daycare center.
- If you have an electric garage door opener, locate the manual override.
- Conduct a home safety evaluation to find out which nearby trees could fall in a windstorm.
- If you live on a coastal or inland shoreline, be familiar with evacuation routes.
- Monitor your portable or weather radio for instructions .

## What to do during a windstorm:

- Turn off the stove if you are cooking when the power goes out and turn off natural gas appliances.
- Never use a gas stove for heat.
- Never burn charcoal indoors.
- Never use a generator indoors or in a garage or carport.
- If you are indoors, move away from windows or objects that could fall. Go to lower floors in multi-story homes.
- If you are outdoors, move into a building. Avoid downed electric power lines, utility poles, and trees.
- If you are driving, pull off the road and stop away from trees. If possible, walk into a safe building. Avoid overpasses, power lines, and other hazards.

## What to do after a windstorm:

- Check yourself and those around you for injuries.
- Call 9-1-1 only to report a life-threatening emergency.
- Evaluate damage buildings, evacuate if necessary. Do not re-enter until declared safe by authorizes.
- If you smell gas or hear a hissing sound indoors - open windows and leave the building. Turn off the gas source and call your gas company. Do not use matches, candles, open flames or electric switches in doors.
- If the power goes out keep refrigerator and freezer doors closed to keep food frozen for up to two days.
- Provide assistance to your neighbors, especially the elderly or disabled.
- Try to make contact with your out-of-area phone contact, but avoid making local calls.
- Continue to monitor your portable or weather radio for instructions or an official "all clear" notice. Radio stations will broadcast what to do, the location of emergency shelters and medical aid stations, and the extent of the damage.



WASHINGTON MILITARY DEPARTMENT  
Emergency Management Division  
Camp Murray WA 98430-5122

Web site [www.emd.wa.gov](http://www.emd.wa.gov)  
253-512 7000 (800) 562 6108



# Winter Storms

Winter Storms can range from moderate snow over a few hours to blizzard conditions with blinding, wind-driven snow or freezing rain that last several days. The time to prepare is before the snow fall or ice forms.

## Preparing for winter storms:

- Listen to your radio or television for winter storm forecasts and other information.
- Prepare your home for cold weather. Install storm windows, insulate outside walls, attics and crawl spaces. Wrap pipes, especially those near cold outer walls or in attics or crawl spaces. Repair leaks in the roof, around the doors, and in the windows.
- Have appropriate cold weather clothing available.
- If you have a kerosene heater, refuel your heater outside and remember to keep it a least three feet from flammable objects.
- Make sure your fireplace functions properly.
- Have rock salt and sand on hand for traction on ice.
- Fill your gas tank before the snow starts falling.

## During a winter storm:

- Wear several layers of loose-fitting, lightweight, warm clothing rather than one layer of heavy clothing. Wear mittens rather than gloves. Wear a warm, woolen cap.
- Reduce the temperature in your home to conserve fuel.
- Heat only the areas of your home you are using. Close doors and curtains or cover windows and doors with blankets.
- Use alternative heat methods safely. NEVER use a gas or charcoal grill, hibachi, or portable propane heater to cook indoors or heat your home.
- Never use a generator indoors or in a garage or carport.
- Be careful when shoveling snow. Do not over exert yourself.
- Be sure to eat regularly. Food provides calories that maintain body heat.
- Do not drive unnecessarily.

- Watch for signs of frostbite and hypothermia — slurred speech, disorientation, uncontrollable shivering, stumbling, drowsiness, and body temperature of 95° Fahrenheit or less.
- If you become trapped outside, get out of the wind and stay dry. Build a lean-to or snow cave if nothing else is available. Do not eat snow; it will make you too cold.

## If in your vehicle:

- Keep an emergency kit in your vehicle. Include a three-day supply of water and non-perishable food that can be eaten without being cooked. Include a blanket or sleeping bag for each passenger, a flashlight, cell phone, shovel, bag of sand or kitty litter, booster cables, flare, coffee can with lid and toilet paper.
- Make sure someone knows where you are going. Stay on the main roads.
- If you must stop, remain inside the vehicle. Use a bright distress flag or your hazard lights to draw attention to your vehicle.
- If trapped in a blizzard, clear your tail pipes and run your engine and heater for 10 minutes every hour. Open your window slightly.
- During night hours, keep the dome light on in the care so rescue crews can see your vehicle.



WASHINGTON MILITARY DEPARTMENT  
Emergency Management Division  
Camp Murray WA 98430-5122

Web site [www.emd.wa.gov](http://www.emd.wa.gov)  
253-512-7000, (800) 562-6108

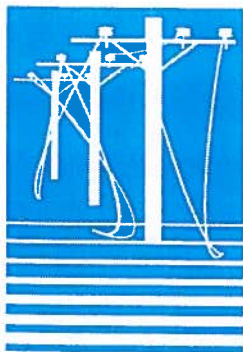

# Power Outages & Generators

Power outages can cause a number of safety concerns; knowing the following information can help.

## Before a power outage:

- Register life-sustaining and medical equipment with your utility company.
- Consider buying a generator. When installing a generator, follow the instructions carefully. Keep your generator outside and run a cord inside. Don't connect your generator to main service panels - it's dangerous! Be sure to place carbon monoxide detectors indoors.
- Make sure your disaster preparedness kit contain light sticks, flashlights, a battery-powered radio with extra batteries and a wind-up clock.
- Have a corded telephone available - cordless phones will not work when the power is out.
- Have a safe alternative heat source and supply of fuel. Never burn charcoal or use a generator indoors.
- If you own an electric garage door opener, know how to open the door without power.

## During a power outage:

- Turn off lights and electrical appliances except for the refrigerator and freezer. Even if it is dark, turn light switches and buttons on lamps or appliances to the "off" position. Leave one light on so you will know when the power is restored.
- Unplug computers and other sensitive equipment to protect them from possible surges when the power is restored.
- Wait at least 15 minutes after the power is restored before turning on other appliances.
- Conserve water, especially if you use well water.

- Never use gas ovens, gas ranges, barbecues or portable propane heaters indoors for heating - they use oxygen and create carbon monoxide that can cause suffocation.
- Using a kerosene heater, gas lantern, or stove inside the house can be dangerous. Maintain proper ventilation at all times to avoid a build up of toxic fumes. Be sure to have carbon monoxide detectors to detect fumes.
- Stay way from downed power lines and sagging trees with broken limbs.

## Use a generator safely:

- If you plan to use a generator, install carbon monoxide (CO) detectors in your home.
- Determine the amount of power you will need to operate items that you plan to plug into the generator.
- Place the generator **away** from windows, doors and vent that could allow CO to come indoors.
- **Never** use a portable generator indoors, in a garage, carport, basement, crawl space or other enclosed or partially-enclosed areas. Doing so may cause CO poisoning: sick, dizzy, weak. *(Get to fresh air fast.)*
- Plug appliances directly into the generator or use heavy duty, outdoor-rated extension cords that are rated (in watts or amps) at least equal to the sum of the connected appliance loads.
- Never try to power the entire house by plugging the generator into a wall outlet. This can causing 'back feeding' and can lead to electrocution of utility workers or neighbors served by the same transformer.
- The only safe way to connect a generator to house wiring is to have a qualified electrician install a power switch transfer.



WASHINGTON MILITARY DEPARTMENT  
Emergency Management Division  
Camp Murray WA 98430-5122

Web site [www.emd.wa.gov](http://www.emd.wa.gov)  
253-512-7000 (800) 562-6108







# Carbon Monoxide Safety



Only use a generator outdoors; far away from open vents, windows and doors.



**Cooking:** Never use a gas cooking grill to cook inside your home.

**Heating:** Never try to heat your home with a gas grill.



**Cooking:** Never use a hibachi to cook inside your home.

**Heating:** Never try to heat your home with a hibachi.

## What is carbon monoxide?

Carbon monoxide is a poisonous gas that cannot be seen or smelled and can kill a person in minutes. Carbon monoxide is produced whenever any fuel such as gas, oil, kerosene, wood, or charcoal is burned.

Hundreds of people die accidentally every year from carbon monoxide poisoning caused by appliances that are not used properly or that are malfunctioning.

Carbon monoxide can build up so quickly that victims are overcome before they can get help.

## Once inhaled, carbon monoxide:

- Can cause permanent brain damage.
- Can cause chest pains or heart attacks in people with heart disease.

## What are the symptoms of carbon monoxide poisoning?

- Headache
- Weakness
- Dizziness
- Confusion
- Fatigue
- Nausea

## What should be done if you suspect someone has been poisoned by carbon monoxide?

- Move the person to a place with fresh air immediately.
- Take the person to an emergency room and tell them that you suspect carbon monoxide poisoning.

## How can I prevent carbon monoxide poisoning?

- Never burn charcoal inside homes, tents, campers, vans, trucks, garages, or mobile homes. Do not burn charcoal in the fireplace in your home.
- Never use gasoline powered equipment indoors.
- Never use a gas oven to heat your home, even for a short time.
- Never sleep in a room while using an unvented gas or kerosene heater.
- Make sure that chimneys and flues are in good condition and are not blocked.
- Never idle a car in a garage, even when the garage door is open.
- Carbon monoxide warning devices may provide additional protection, but should not replace the other prevention steps.



WASHINGTON MILITARY DEPARTMENT  
Emergency Management Division  
Camp Murray, WA 98430-5122

Web site [www.emd.wa.gov](http://www.emd.wa.gov)  
253-512-7000, (800) 562-6108



# Vehicle Safety & Preparedness

Before leaving home make sure you have your Vehicle Safety Kit and a Personal Survival Kit in your vehicle. Prepare to be on your own for at least 24-hours. The first rule of winter comfort and survival is to stay dry.

## Vehicle Safety Kit:

- ABC-type fire extinguisher (know how to use it)
- Battery-operated/crank radio/extra batteries
- Cat litter/sand for traction on ice/snow
- Chains
- Compass
- Flashlight/extra batteries/crank type
- Ice Scraper
- Jumper Cables
- Utility Knife
- Latex Gloves (2 pair)
- Light Sticks
- Map of Area
- Plastic Shelter Tarps
- Plastic Storage Bags
- Road Flares
- Shovel

## Winterize Your Vehicle - check these:

- Antifreeze
- Battery
- Belts
- Brakes
- Cooling System
- Defroster
- Exhaust System
- Fluid levels
- Proper grade oil
- Heater
- Ignition system
- Lights
- Tires
- Pressure
- Tread
- Traction (studs/snow)
- Washer fluid
- Wiper blades

## Personal Survival Kit:

- Food - Choose whole grain cereals, nuts, energy bars, and food with high liquid content; avoid food that makes you thirsty

*Remember a portable can opener if you pack canned food.*

- Water - 1 gallon per person for a 24-hour period
- Gloves, hat, sturdy shoes, jacket, etc.
- Rain Gear
- Blankets - Mylar and other
- First Aid Kit/Medications
- Cash, coins for phones
- Cell Phone
- Whistle
- Games/Books
- Pet Supplies
- Toilet Paper
- Hand Sanitizer/Towelettes
- Feminine/Personal hygiene items
- Infant diapers and wipes
- Infant formula/food
- Special diet foods

## Remember...

- Fill the gasoline tank before leaving; stop to fill up long before the tank begins to run low.
- Start early. Remember the posted speed limits are for dry pavement.
- Don't try to out-drive the conditions and always drive with your headlights on.
- Use brakes carefully; leave plenty of room for stopping; it takes more time to stop in adverse conditions.
- Look farther ahead in traffic to gain extra time to safely react to situations.
- Remember that trucks take longer to safely respond, avoid cutting quickly in front of them.
- Don't use cruise control in wintry conditions.
- Don't get overconfident in your 4x4 vehicle - they can lose traction as quickly as a 2-wheel drive vehicle.



WASHINGTON MILITARY DEPARTMENT  
Emergency Management Division  
Camp Murray WA 98430-5122

Web site [www.amd.wa.gov](http://www.amd.wa.gov)  
253 512-7000, (800) 562-6108



# Taking Care Psychological and Emotional Needs

It is natural to be upset when you think your health or the health of your loved ones is threatened. Pay attention to your own feelings and take care of your emotional needs, then you can better help friends and family members handle their concerns.

## Coping with Uncertainty:

Anxiety can be related to fear of the unknown. It is normal to feel anxious and worried during an emergency.

## Reactions to Emergencies:

People often experience changes in their physical, emotional, or mental state during and after emergencies. For example, they may have trouble sleeping, experience anger or depression, or have problems at work or school. These are among the many normal reactions to an emergency situation. There are things you can do to cope with these problems. However, if these reactions seem extreme or last for a long time, the person suffering the condition should seek help.

## Coping with Stress and Anxiety:

- Limit your exposure to graphic news stories.
- Get accurate, timely information from reliable sources.
- Learn more about the specific hazard.
- Maintain your normal routine, if possible.
- Avoid drugs and excessive drinking.
- Exercise, eat well and get enough sleep.
- Stay active physically and mentally.
- Stay in touch with family and friends.
- If you can, help others.
- Keep a sense of humor.
- Share your concerns with others.

## Stay Connected:

It is important to stay connected with others. Use the telephone and email or other social media tools.

Ask for help if you need it. If your anxiety gets in the way of your daily life, talk to someone you trust. This may be your doctor, a family member, friend, clergy member, teacher, or mental health professional.

If you notice a big change in a loved one, friend, or coworker reach out to them. Make some time to talk. Watching out for others shows you care and it can be comforting for both of you.

If you or someone you know is having a hard time managing emotions, seek help from a medical or mental health professional.

## Get Reliable Information:

When an emergency happens, it is important to keep things in perspective. Get information about the event from:

- Newspaper, radio, television
- Your local Emergency Management Office
- Washington State Emergency Management



WASHINGTON MILITARY DEPARTMENT  
Emergency Management Division  
Camp Murray, WA 98430 5122

Web site: [www.emd.wa.gov](http://www.emd.wa.gov)  
253-512-7000, (800) 562-6108

Specific Needs  
Emotional Needs

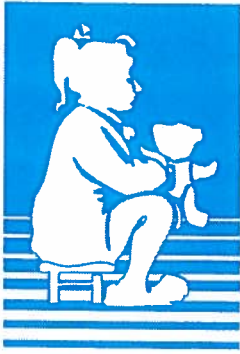

# Helping Children After a Disaster

It's important to remember some children may never show distress, while others may not give evidence of being upset for several weeks or even months after an emergency. Other children may not show a change in behaviors, but may still need your help.

## Children may exhibit the following behaviors after a disaster:

- Be upset over the loss of a favorite toy or possession that is important to them.
- Change from being quiet, obedient, and caring to loud, noisy, and aggressive or change from being outgoing to being shy and afraid.
- Develop night-time fears (nightmares, fear of the dark or sleeping alone).
- Be afraid the event will reoccur.
- Become easily upset.
- Lose trust in adults. (After all, their adults were not able to control the disaster.)
- Revert to younger behavior (bed-wetting, thumb-sucking).
- Want to stay close to parents. Refuse to go to school or daycare.
- Feel they caused the disaster because of something they said or did.
- Become afraid of wind, rain, or sudden loud noises.
- Have symptoms of illness, such as headaches, vomiting, or fever.
- Worry about where they and their family will live.

## Things parents can do to help their children:

- Talk with children about how they are feeling. Assure them that it's okay to have those feelings.
- Help children learn to use words that express their feelings, such as "happy", "sad", or "angry".
- Children should not be expected to be brave or tough. Tell them it's okay to cry.
- Don't give the children more information than they can handle about the disaster.
- Assure fearful children you will be there to care for them; constantly reassure them.
- Reassure children that the disaster was not their fault.

- Go back to former routines as soon as possible. Maintain a regular schedule for the children.
- Let children have some control, such as choosing clothing and what meal to have for dinner.
- Re-establish contact with extended family members.
- Help your children learn to trust adults again by keeping promises you make.
- Help your children regain faith in the future by making plans.
- Get needed health care as soon as possible.
- Spend extra time with your children at bedtime.
- Make sure children eat healthy meals and get enough rest.
- Allow special privileges for a short period of time, such as leaving the light on when they go to bed.
- Find ways to emphasize to your children that you love them.
- Allow children time to grieve losses.
- Develop positive anniversary activities to commemorate the event. These may bring tears, but they are also a time to celebrate survival and the ability to get back to a normal life.

## NOTE:

- Children who experience an initial traumatic event before they are 11 years old are 3 times more likely to develop psychological symptoms than those who experience their first trauma later.
- Children are able to cope better with a traumatic event if parents and other adults support and help them with their experiences.
- Help should start as soon as possible.



WASHINGTON MILITARY DEPARTMENT  
Emergency Management Division  
Camp Murray, WA 98430 5122

Web site [www.emd.wa.gov](http://www.emd.wa.gov)  
253-512-7000, (800) 562-6108



# Disaster Tips for People with Special Medical Needs

In a disaster, people with special medical needs have extra concerns. This information will help you and your family think about what extra supplies and equipment each of you may need to be prepared.

## Medications:

- Always have at least a three-day supply of all your medications. In some emergencies, such as influenza pandemic, you may need to prepare for a week or more.

*Talk to your pharmacist about getting an emergency supply or re-order your prescriptions 2-3 days ahead of time and place the unused medications in your old prescription bottles.*

- Store your medications in one location in their original containers.
- Have a list of all your medications: name of medication, doses, frequency, and the name of the prescribing doctor.

## Medical Supplies:

- Have an extra three-day supply of any medical supplies you use such as bandages, ostomy bags, or syringes.

## Electrically Powered Medical Equipment:

- For all medical equipment requiring electrical power - beds, breathing equipment, or infusion pumps - check with your medical supply company and get information regarding a back-up power source such as a battery or generator.

## Oxygen and Breathing Equipment:

- If you use oxygen, have an emergency supply; enough for a least a three-day period.
- Oxygen tanks should be securely braced so they do not fall over. Call your medical supply company regarding bracing instructions.
- If you use breathing equipment, having a three-day supply or more of tubing, solutions, and medications.

## Intravenous (IV) and Feeding Tube Equipment:

- Know if your infusion pump has battery back-up, and how long it would last in an emergency.
- Ask your home care provider about manual infusion techniques in case of a power outage.
- Have written operating instructions attached to all equipment.

## Emergency Kit:

- In the event that you have to leave your home, keep a bag packed at all time that contains:
  - A medication list.
  - Medical supplies for a least three days.
  - Copies of vital medical papers such as insurance cards and power of attorney.

## People Who Can Help:

- An important part of being prepared for disaster is planning with family, friends, and neighbors. Know who can walk to your home to assist you if no other means of transportation is available.
- Discuss your disaster plans with your home healthcare provider.
- Ask you local fire department if they keep a list of people with special medical needs; ask to be include if they do maintain a list.
- Keep a phone contact list handy of people who can help.



WASHINGTON MILITARY DEPARTMENT  
Emergency Management Division  
Camp Murray, WA 98430-5122

Web site: [www.emd.wa.gov](http://www.emd.wa.gov)  
253-512-7000 (800) 562-6108

Specific Needs  
Special Medical Needs



# Disaster Tips for People with Mobility Disabilities

People who have mobility impairments may face unique challenges in an emergency. Make sure you prepare before a disaster strikes, so that you will have the necessary items that you will need during the emergency.

## Storage:

- Store emergency supplies in a pack or backpack attached to a walker, wheelchair, or scooter.
- Store needed mobility aids (canes, crutches, walkers, wheelchairs) close to you in a consistent, convenient, and secured location. Keep extra aids in several locations, if possible.

## Emergency Supply Kit:

- Keep a pair of heavy gloves in your supply kit to use while wheeling or making your way over glass or debris.
- If you use motorized wheelchair or scooter, consider having an extra battery available. A car battery can be substituted for a wheelchair battery, but this type of battery will not last as long as a wheelchair's deep-cycle battery. Check with your vendor to see if you will be able to charge batteries by either connecting jumper cables to a vehicle battery or by connecting batteries to a specific type of converter that plugs into your vehicle's cigarette lighter in the event of loss of electricity.
- If your chair does not have puncture-proof tires, keep a patch kit or can of "fix-a-flat" air product to repair a flat tire, or keep an extra supply of inner tubes.
- Store a lightweight manual wheelchair, if available.
- Make sure furniture is secured so that it doesn't block the pathways you normally travel.

- If you spend time above the first floor of a building with an elevator, plan and practice using alternative methods of evacuation. If needed, enlist the help of your personal support network.
- If you cannot use stairs, discuss lifting and carrying techniques that will work for you. There will be times when wheelchair users will have to leave their chairs behind in order to safely evacuate a structure.
- Sometimes transporting someone down stairs is not practical solution unless there are two or more strong people to control the chair. It is very important to discuss the safest ways to transport you if you need to be carried. Alert helpers to any areas of vulnerability. For example, the traditional "firefighter's carry" may be hazardous to some people with respiratory weakness.
- Be prepared to give helpers brief instructions on the best way to move you.



WASHINGTON MILITARY DEPARTMENT  
Emergency Management Division  
Camp Murray, WA 98430-5122

Web site: [www.emd.wa.gov](http://www.emd.wa.gov)  
253-512-7000, (800) 562-6108

Specific Needs  
Mobility Disability

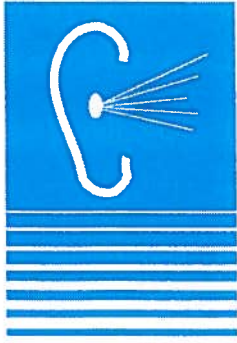

# Preparedness Tips for the Deaf and Hard of Hearing

People who are deaf or have hearing impairments, may face unique challenges in an emergency. Take a few minutes to assess your needs and start preparing.

## Hearing Aids:

- Store hearing aids where you can easily find them after a disaster. For example, you could keep them in a container by your bedside and attach the container to a nightstand or bedpost using a string or Velcro. Missing or damaged hearing aids will be difficult to replace or fix immediately after a major disaster.

## Batteries:

- Store extra batteries for hearing aids and implants. If possible, store an extra hearing aid with your emergency supplies.
- Keep your pager, captioned telephone, and other communication equipment charged.
- Maintain batteries and store extras for your TTY and other communications equipment. Check the owner's manual for proper battery maintenance.

## Communication:

- Know how to communicate with emergency personnel if there is no interpreter or if you don't have your hearing aids. Store paper and pens for this purpose.
- Consider carrying pre-printed copy of important message with you, such as:
  - I use American Sign Language (ASL) and need an ASL interpreter.
  - I do not speak or read English.
  - If you make announcements, I will need to have them written or signed.
- If possible, get a battery-operated TV that has a decoder chip for access to signed or captioned emergency reports.
- Determine which broadcast systems will provide continuous captioned and/or signed news.

## Alarms:

Install smoke alarms that give signals that can be both seen and heard. At least one smoke alarm should be battery operated.

## Advocacy issues:

- Recruit interpreters to be Red Cross emergency volunteers.
- Encourage TV stations to broadcast all news and emergency information in open caption format.
- Encourage TV stations to plan to provide interpreters for on-camera duty during emergencies.
- When you travel, be sure hotels have services for the deaf and hard of hearing, including visual alarms. Ask for them when you check in.



WASHINGTON MILITARY DEPARTMENT  
Emergency Management Division  
Camp Murray, WA 98430-5122

Web site: [www.amd.wa.gov](http://www.amd.wa.gov)  
253-512-7000 (800) 562-6108

Specific Needs - Deaf  
Hard of Hearing



# Disaster Tips for People with Visual Disabilities

People who have visual disabilities may face unique challenges in an emergency. If you need to wear eyeglasses or contact lenses you are also considered a person with an eyesight disability.

**Extra Items:** *place them where they are easily accessible.*

#### Glasses:

- If you use glasses, plan to keep extra pairs available.

#### Contact Lens:

- If you wear contact lens, plan to keep extra ones with you in case you are unable to return home. Carry an extra lens case and lens solution, if necessary.

#### Canes:

- If you use a cane, keep extras in a strategic, consistent and secured locations at work, home, school and volunteer sites to help you maneuver around obstacles and hazards.
- Keep a spare cane in your emergency kit.

#### Alternative mobility cues:

- If you have some vision, place security lights in each room to light paths of travel. These lights plug into electric wall outlets and light up automatically if there is a loss of power. They will, depending on the type, continue to operate automatically for 1 to 6 hours. They can also be turned off manually and used as a short-lasting flashlight.
- Store high-powered flashlights with wide beams and extra batteries.
- Plan for losing the auditory clues you usually rely on after a major disaster.
- Service animals may become confused, frightened, or disoriented during and after a disaster. Keep them confined or securely leashed or harnessed. A leash/harness is an important item for managing a nervous or upset animal. Be prepared to use alternative ways to negotiate your environment.

#### Label supplies:

- If helpful, mark emergency supplies with large print, fluorescent tape, or Braille.

#### Secure computers & furniture:

- Anchor special equipment and large pieces of furniture such as computers and shelving. Create a computer back-up system for important data and store it off site.

#### Advocacy issues:

- Advocate that TV news not only post important phone numbers, but also announce them slowly and repeat them frequently for people who cannot read the screen.



WASHINGTON MILITARY DEPARTMENT  
Emergency Management Division  
Camp Murray WA 98430-5172

Web site [www.emd.wa.gov](http://www.emd.wa.gov)  
253 512-7000 (800) 562-6108